



UL[®]
E48329



Timer with Instantaneous Relay

- On-Delay version with instantaneous relay
- Selectable On-Delay/Interval Timing Mode version
- Output Contacts rated 10A 120/240 VAC and 30 VDC
- Six Timing Ranges in a single unit
- Timing Ranges:
 - 1 and 10 SEC, MIN, and HRS
 - 5 and 50 SEC, MIN, and HRS
- Universal Power Supply: 24-240 VAC and 24 VDC
- 48mm² DIN Standard housing
- Large and easy to read dial shows decimal points
- Round (octal) socket mount or mount in panel cutout
- Range and Mode select are tamper proof when panel mounted
- Unique flashing cycle progress indication

INSTANTANEOUS & DELAYED: A version of the 405 is available with one set of SPDT instantaneous contacts and one set of SPDT delayed contacts. The instantaneous contacts transfer as soon as the timer is powered. The delayed contacts transfer at time out. This contact arrangement can be used to replace many conventional timers.

ON DELAY/INTERVAL TIMING MODE VERSION: A version of the 405 is available with selectable ON-delay or Interval timing modes. This version has a set of DPDT output contacts. When in the ON-delay mode, the contacts transfer at time out. When in the Interval mode, the contacts transfer when power is applied and release at time out.

UNIVERSAL POWER: All 405 timers can be powered using 24-240 VAC or 24 VDC power, greatly simplifying ordering and inventory management of replacement units.

1/16 DIN HOUSING: The 48mm² (1/16 DIN) housing is compact design. The 405 is mounted in an 8-pin round (octal) socket. With an optional mounting clip, the 405 can be panel mounted.

The Dial on the 405 is extra-large and is easy to read. When fractional ranges are selected, decimal points are clearly indicated.

The Mode select and Range select switches are located on the side of the unit, so that when panel mounted, these switches are not accessible to the operator. This tamper proof feature prevents unauthorized or hazardous changes to the timing mode and range from being made.

CYCLE PROGRESS INDICATION: The 405 LED indicator provides a unique and effective method of cycle progress indication. Off before timing, the LED blinks at an ever increasing rate as the cycle progresses: once every 3-1/2 seconds during the first 10% of the cycle, twice during the second 10%, and so on. At time out, the LED pulses at a high rate. (In the 1, 5, 10 and 50 second ranges, the LED is OFF before timing, steady ON during timing, and pulsing ON after time-out).

Timing begins when the start switch is closed. This starts an oscillator which runs at a frequency determined by the time setting. A fixed number of counts from the oscillator determines the end of the timing cycle. The time required to accomplish this depends upon the oscillator frequency. During timing, an LED located on the dial face blinks. For the first 10% of the cycle, LED repeatedly blinks once followed by a pause. For the second 10%, it blinks twice and so on indicating the cycle progress. The LED flashes rapidly and continuously after time out.

OPERATIONS

MODEL...F1X

The instantaneous contacts (3-1-4) transfer immediately after the start switch is closed. The delayed contacts (6-8-5) transfer after the timing cycle indicated on the front dial setting. Both contacts remain transferred until the unit is reset.

MODEL...F2X

ON DELAY MODE: At time out, the DPDT relay transfers its contacts. These contacts remain transferred until the start switch is opened or power is removed by some other means. The 405 then resets and is ready for another cycle.

INTERVAL MODE: When the start switch is closed, the DPDT relay transfers its contacts. The contacts remain transferred until time out. The timer will not start again until the start switch is opened or power is removed by some other means. The 405 then resets and is ready for another cycle.

SPECIFICATIONS

MODELS	405C100F1X ON-Delay w/instantaneous & delayed relays (1 or 10 SEC/MIN/HRS)
	405C500F1X ON-Delay w/instantaneous & delayed relays (5 or 50 SEC/MIN/HRS)
	405C100F2X ON-Delay/Interval with (1) DPDT relay (1 or 10 SEC/MIN/HRS)
	405C500F2X ON-Delay/Interval with (1) DPDT relay (5 or 50 SEC/MIN/HRS)
	Both models available in 6 ranges from 1 SEC to 10 HRS or 5 SEC to 50 HRS

CONTACT RATING	Rated 10 AMPS resistive at 30 VDC or 250 VAC (or less)
	1/8 HP @ 120 VAC
	1/4 HP @ 240 VAC
	240 VA @ 240 VAC
	LIFE: 10 million operation with no load 100,000 operations with: 10 AMPS at 30 VDC (or less) or 10 AMPS at 250 VAC (or less)

CONTACT MATERIAL	Silver Nickel
-------------------------	---------------

TEMPERATURE RATING	0 to 122°F (-18 C to 50 C)
---------------------------	----------------------------

MOUNTING	Plug-in octal base; mounts in any position w/ retaining clip
	Options: Surface mounting socket DIN rail mounting socket Panel-mounting adapter kit Plug-on socket kit

POWER REQUIREMENTS	Universal power supply - reverse polarity protected
	Unit will accept power from 24 to 240 VAC, 50 or 60 Hz, (+10%, - 20%)
	AC Inrush - 1.5 Amps Power required - 1.2 watts
	DC Maximum ripple @100 Hz - 5% Current required - 50mA Power required - 1.2 watts
	F option Peak inrush current = 2 AMPS @ 24 VDC N option Peak inrush current = 150 mA @ 24 VDC

REPEAT ACCURACY	Varies as a function of temperature.
	Any voltage (constant temperature): ±0.5%*
	Any voltage (0°F to 140°F): ±2.0%*
	*Variation from average actual time.

MINIMUM SETTING	2% of range, with the exception of 50 mSEC on the 1 second range
------------------------	--

SETTING ACCURACY	± 5% of range
-------------------------	---------------

RESET	a 0 to 20 mSEC power interruption: guaranteed no reset.
	b 20 to 65 mSEC; it may reset (40 mSEC typical reset).
	c Over 65 mSEC guaranteed to reset.
	The TDR will reset properly and not start timing when subjected to an open start switch leakage of 1.5 mA or less. (Prox switch and Triac drive applications)

WEIGHT	5 oz. (140 g)
---------------	---------------

WIRING

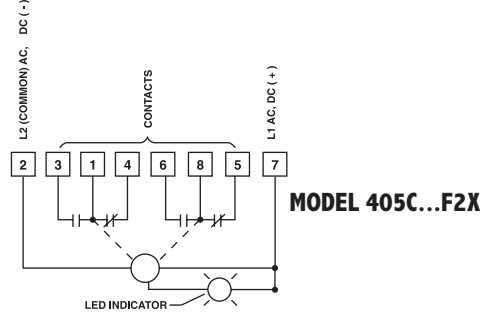
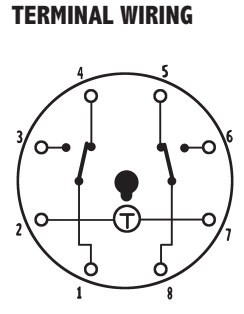
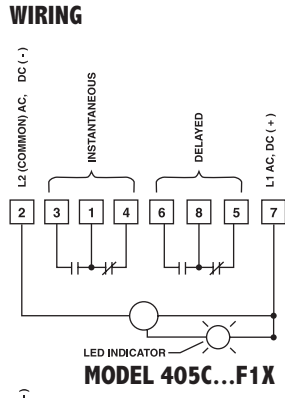

MODEL NUMBER

MODEL NUMBER	405C				
RANGE	Six dial-selected ranges (1 or 10 SEC/MIN/HRS)	100			
	Six dial-selected ranges (5 or 50 SEC/MIN/HRS)	500			
VOLTAGE & FREQUENCY	12 VDC		E		
	24 to 240 VAC (50/60 Hz) and 24 VDC		F		
	24 VDC (low inrush current for short-circuit protected sensors)		N		
ARRANGEMENT	8-Pin ON-Delay (with instantaneous contacts) Timing Mode			1	
	8-pin ON-Delay, Interval Timing Modes			2	
FEATURES	Standard				X
	Special				K

ACCESSORIES	8-Pin surface/DIN rail socket	000-825-85-00
	Hold down for above socket (Requires 2 per unit)	407-025-13-00
	Panel mounting bracket	405-320-02-00
	Plug-in socket kit (8-pin)	319-261-45-00
	8-Pin panel socket w/rear facing terminals	000-825-90-00

DIMENSIONS (INCHES/MILLIMETERS)

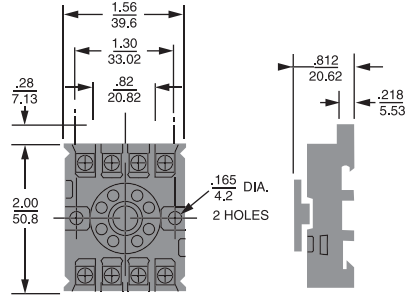
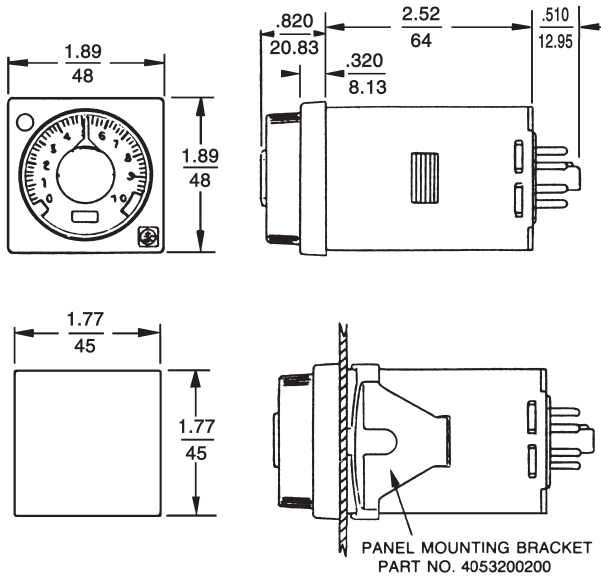

8 PIN OPTIONAL OCTAL SOCKET NO. 00008258500

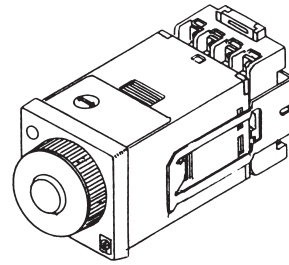

TYPICAL CIRCUITS

405C... F1X

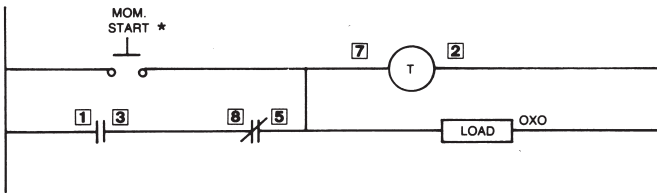

*Minimum Momentary Switch Closure Time - 50 mSEC

405C... F2X

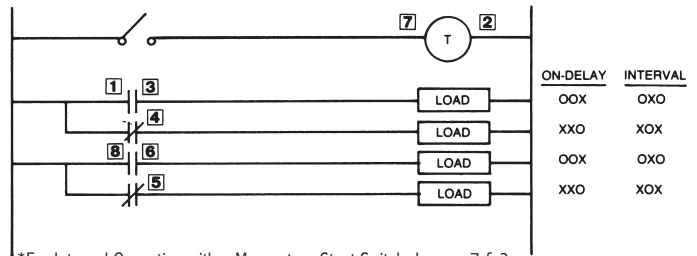

*For Interval Operation with a Momentary Start Switch, Jumper 7 & 3

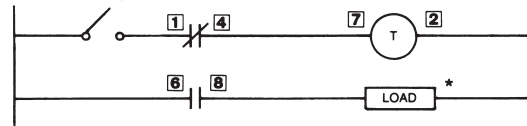
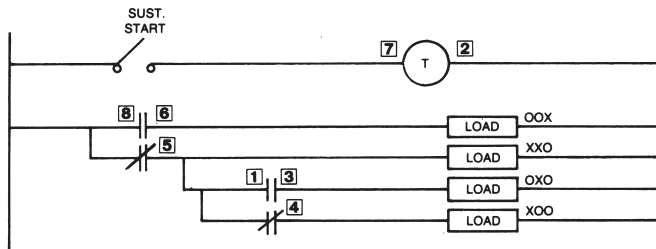

*Load Will Pulse On For 30 -60 mSEC

