



HIGH-PRESSURE VALVES AND SYSTEM COMPONENTS



OUR PRODUCTS ARE BACKED BY OUTSTANDING TECHNICAL SUPPORT, AN EXCELLENT REPUTATION FOR RELIABILITY AND WORLDWIDE DISTRIBUTION



TABLE OF CONTENTS



Haskel International, Inc.
Burbank, California, U.S.A.



Haskel Energy Systems, Ltd.
Sunderland, England, U.K.

Haskel International, Inc. has almost 50 years of hydraulic and pneumatic engineering experience in the design and manufacture of air driven gas boosters, air amplifiers and liquid pumps. Located in Burbank, California, U.S.A., with an additional manufacturing plant in Sunderland, United Kingdom, the company is supported by a worldwide network of offices and distributors.

Haskel products now offer the most complete range in this industry, whether measured by ultimate pressure flow or output horsepower capability; or by the variety of media with which they are compatible. The high-pressure valves and system components described in this catalog have been designed to assist in the controlled use of pressure and flow-generating equipment manufactured by Haskel, as well as others.

Continuous investment in the most modern machinery and technology ensures that Haskel will remain the leader in this field.

| | Page |
|---|---------|
| Stainless Steel Check Valves | 3 |
| Air Pilot Switches | 4 – 5 |
| Air Pilot Switches — Selection Charts | 6 – 7 |
| Air Operated Directional Control and Release Valves | 8 |
| Air Piloted Valves — Typical Applications | 9 |
| Air Piloted Valves — Selection Charts | 10 – 11 |
| Regulating Relief Valves | 12 – 13 |
| Hydraulic Accumulators and Gas Receivers | 14 |
| Filters | 15 |
| Plenum Chambers | 15 |
| 6000 PSI Gas Storage Cylinder | 15 |

STAINLESS STEEL CHECK VALVES



Combining the best features of durability and positive sealing, these unique valves are constructed throughout of 316 Series Stainless Steel for the high corrosion resistance essential in the chemical, processing and power generating industries.

PTFE seat seal for positive bubble-tight sealing (with gas) from cryogenic to 375° F (190°C) temperatures. Seals also available for radioactive environments, or up to 500°F steam. Can be furnished without soft seat for higher temperature steam service.

Sizes 1/4" through 1" use a ball, and for reduced inertia, the larger sizes (1-1/4", 1-1/2" and 2") use a poppet. Cracking pressure is 1-4 psi.

Larger valves can be furnished for flange mounting to customer specifications on special quantity orders. Consult factory.

Semi-soft means the check ball or poppet initially seats on the PTFE, but after the PTFE deflects a slight amount, the ball or poppet comes to rest against the metal seat so the PTFE does not have to absorb the full load of the high pressure.

Internal passages have flow capacity equal to or greater than double extra heavy pipe of the same size that would be required to carry the rated pressure (see CV factor in chart below).

Typical of good Haskel design is the removal of springs from the flow path. The larger spring is outside the flow path and simply provides a preload for the disk. The smaller spring, inside the cage, actuates the ball or poppet but the flow, which is routed through the cage windows, misses the spring entirely. This is why the valves will stand extremely high shock loads and have been tested at rapid high shock up to 2 million cycles without failure.

| MODEL NUMBER | NPT-SIZE (Other ports optional at extra cost) | DIMENSIONS | | MINIMUM ORIFICE | CV | MAX. WORKING PRESSURE @ 375°F MAX. | |
|--------------|--|------------|--------|-----------------|-------|------------------------------------|------------|
| | | A | B | | | HYDRAULIC | GAS |
| 28201 | 1/4" | 2-1/2" | 13/16" | .156" | .44 | 15,000 psi | 10,000 psi |
| 56790 | 3/8" | 2-7/8" | 1" | .250" | 1.10 | 15,000 psi | 10,000 psi |
| 28303 | 1/2" | 3-1/8" | 1-1/8" | .344" | 2.10 | 15,000 psi | 10,000 psi |
| 28624 | 3/4" | 3-1/4" | 1-3/8" | .486" | 4.20 | 15,000 psi | 10,000 psi |
| 28400 | 1" | 4-1/4" | 1-3/4" | .540" | 5.20 | 12,000 psi | 8000 psi |
| 54080 | 1-1/4" | 4-5/8" | 2-1/4" | .900" | 14.50 | 7500 psi | 6000 psi |
| 53520 | 1-1/2" | 5-1/2" | 2-3/4" | 1.045" | 19.60 | 6000 psi | 5000 psi |

For oxygen service, add -10 after model no. (e.g., 28303-10) 5000 psi maximum.

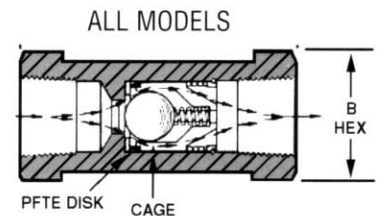

AIR PILOT SWITCHES



STYLE A

Externally Adjusted

- 19 models
- Sensing pressures to 25,000 psi
- Air valve* 3-way, 2-way normally open or closed



STYLE B

Remote Air Adjusted “Remoteset”™

- 4 models
- Sensing pressures to 60,000 psi
- Air valve* 3-way normally closed, 2-way normally closed, normally open



STYLE C

Internally Adjusted

- 34 models
- Sensing pressures to 60,000 psi
- Air valve* 3-way normally closed, 2-way normally closed, normally open

Description

An Air Pilot Switch is a pressure switch. These units produce a pneumatic signal up to 150 psi at any sensing pressure within their adjustment range. The signal valve may be piped normally open, normally closed*, 3-way or 2-way depending on model.

All models use a 2-position poppet-type air signal valve which is shifted from its normal position by a rod from the sensing end which first must overcome an adjustable force spring (styles A and C) or air-regulated dome loader (style B).

Applications

- Direct automatic start/stop control of any Haskel pump, gas booster, air amplifier or indirectly to the drive of any pump or compressor sensing either output or suction (schematics 1 & 2)
- Valve actuators (schematic 5)
- Pneumatic alarm signals
- Replace an explosion-proof pressure switch in hazardous applications (schematic 6)

* Air valve terminology is the reverse of an electrical switch. Closed means no flow; open means flow.

Application Schematics

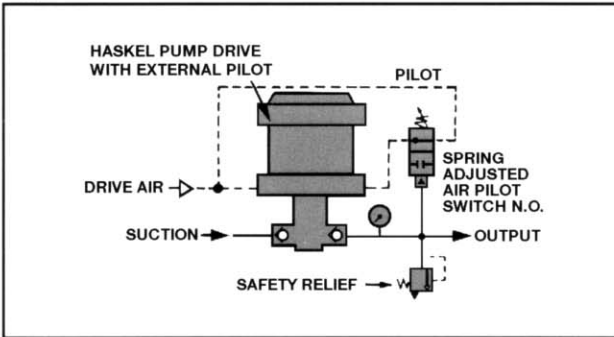

1. Maximum output pressure control, spring adjusted

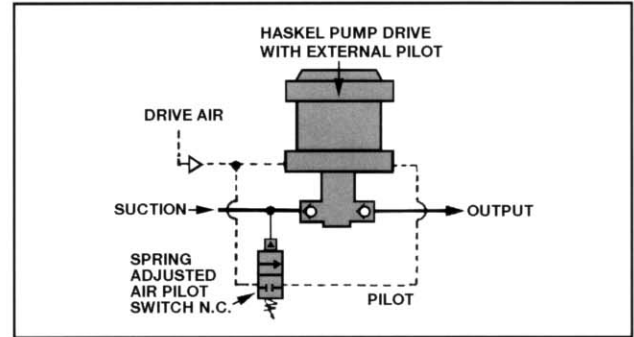

2. Minimum suction pressure control, spring adjusted

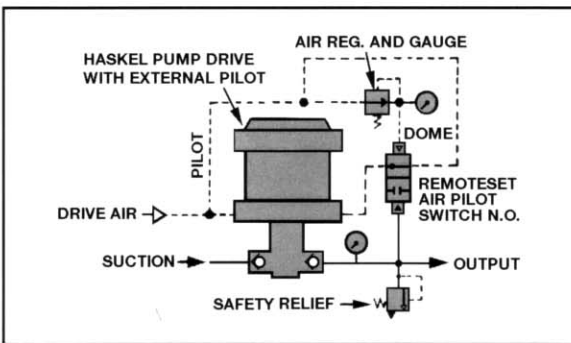

3. Maximum output pressure control remote, air adjusted

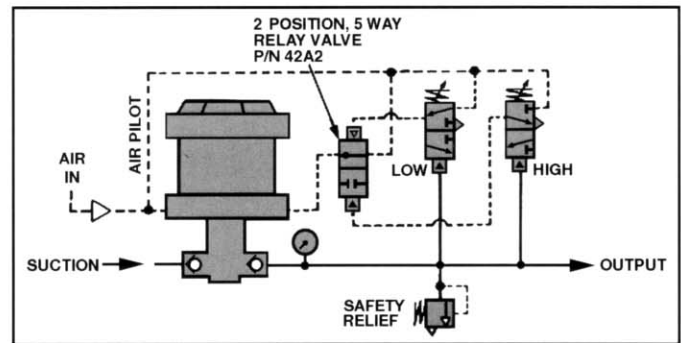

4. Wide deadband control with two adjustable air pilot switches plus a two-position valve

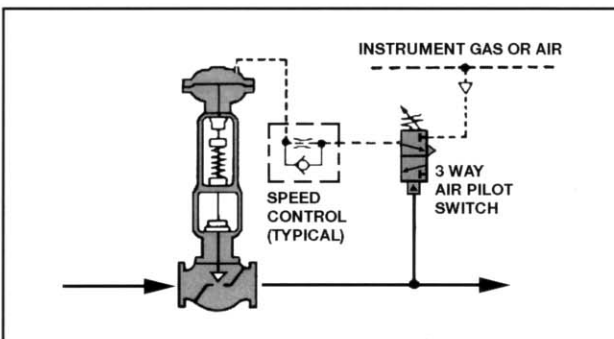

5. Process valve control

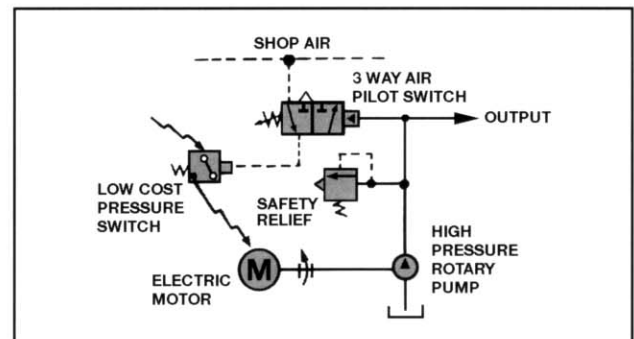

6. Electric pump/motor control where standard pressure switches are unsuitable at pump output

A word about "deadband"

Users often try to compare the on-off action of the air signal with the action of an electrical switch. They are not really comparable. The air switch has no "snap-over" mechanism required with an electric switch to prevent arcing. Therefore, "on" or "off" before or after a dead tight seal condition can be quite subjective. In other words, if the air pilot switch is turning on a device that not only requires a miniscule leak to start, it will start much sooner than some other larger device that may need a flow of air to start.

Therefore, it is not possible to publish precise deadband data such as that available for most electric pressure switches.

Style B Remoteset units have the lowest and most consistent deadband (5% - 10% of set pressure) because there is no heavy coil spring to compress.

Styles A and C may vary from 5% to as high as 40% depending on model and the application details.

In some applications a wider than normal deadband is needed. Schematic 4 illustrates how to provide this with two air pilot switches and a simple 2-position air valve.

AIR PILOT SWITCHES — SELECTION CHARTS

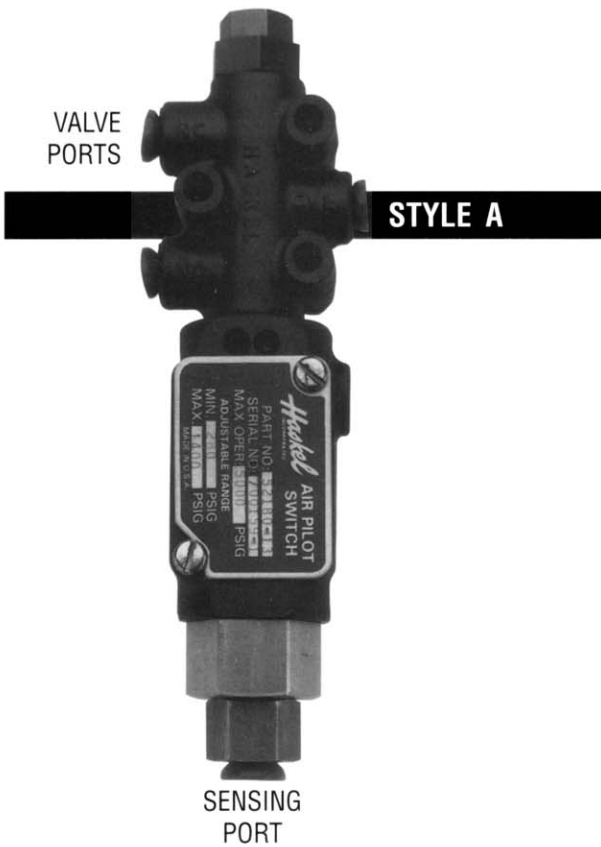

| STYLE | MODEL NO. | | MAXIMUM SENSING PRESSURE (PSI) | AIR VALVE | ADJUSTABLE RANGE PSI FACTORY SETTING AT NO CHARGE (Specify if Increasing or Decreasing) | | APPROXIMATE DIMENSIONS (inches) | | PORTS | |
|-------|----------------------|------------|--------------------------------|---|---|-----------------|---------------------------------|--------------|---------------------|---------------------|
| | SERVICE SENSING PORT | | | | NORMALLY OPEN | NORMALLY CLOSED | LENGTH | OUTSIDE DIA. | AIR (2) | SENSING (3) |
| | LIQUID OR GAS | OXYGEN GAS | | | | | | | | |
| A | 51940-1 | -11 | 10,000 Standard 5000 Oxygen | (1) 3-Way. May be piped N.C. or N.O. or 2-Way N.C. or N.O. | 2000 - 10,000 | 3500 - 10,000 | 8 | 2 | 1/8" NPT | 1/4" NPT |
| | 51940-2 | -12 | | | 700 - 4400 | 1200 - 4800 | | | | 1/4" Super-pressure |
| | 51940-3 | -13 | | | 200 - 950 | 500 - 1300 | | | | 1/4" NPT |
| | 52160-1 | N/A | 25,000 | | | 8-5/8 | 2 | 1/8" NPT | 1/4" Super-pressure | |
| | 52160-2 | | | 6000 - 11,000 | 7000 - 12,000 | | | | | |
| | 52160-3 | | | 8000 - 25,000 | 10,000 - 25,000 | | | | | |
| | 52180-1 | -11 | 10,000 Standard 5000 Oxygen | | | 7-5/8 | 2 | 1/8" NPT | 1/4" NPT | |
| | | | | 60 - 240 | 150 - 300 | | | | | |
| | | | | | | | | | | |

| STYLE | MODEL NO. | SERVICE SENSING PORT | MAXIMUM SENSING PRESSURE (PSI) | AIR VALVE | ADJUSTABLE RANGE PSI FACTORY SETTING AT NO CHARGE (Specify if Increasing or Decreasing) | APPROXIMATE DIMENSIONS (inches) | PORTS | RATIO | |
|-------|-----------|----------------------|--------------------------------|--|---|---------------------------------|----------|---------------------|-------|
| | | | | | | | | | |
| B | 55792 | N/A | 25,000 | 3-Way. May be piped N.C. or N.O. or 2-Way N.C. or N.O. | 4500 - 23,400 with 20-100 Dome Load. Nominal Ratio 245:1 | 8-3/4 | 1/8" NPT | 1/4" Super-pressure | 245:1 |
| | 55796 | N/A | 600 | | 135 - 530 with 20-100 Dome Load. Nominal Ratio 6:1 | 7-1/2 | | 1/4" NPT | 6:1 |

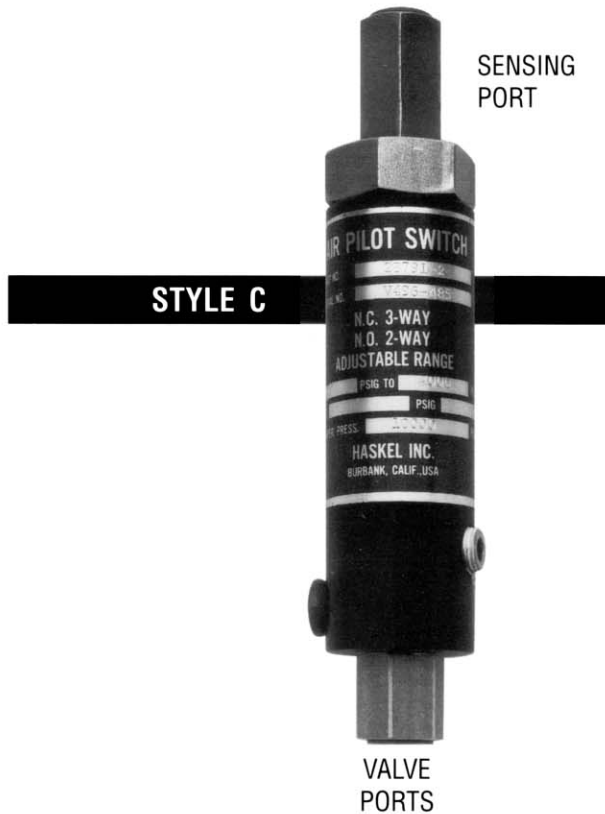

Notes:

- (1) SAFETY: When using N.O. models to limit pump output pressure, also include a backup relief valve. (Ref. schematics 1, 3, 4, 6, page 5.)
- (2) AIR VALVE: Materials are Aluminum, Stainless Steel, Bronze, and Buna suitable for air and most gases. Modification available for sour natural gas to meet NACE SPEC. MR-01-75.
- (3) SENSING SECTIONS: Materials are Stainless Steel, PTFE, Buna (with Viton or Silicone for Oxygen) suitable for most liquids or gases. Modification available for sour natural gas and fire-resistant hydraulic fluids.

| STYLE | MODEL NO. | | MAXIMUM SENSING PRESSURE (PSI) | AIR VALVE | ADJUSTABLE RANGE PSI FACTORY SETTING AT NO CHARGE (Specify if Increasing or Decreasing) | | APPROXIMATE DIMENSIONS (inches) | | PORTS | | |
|----------|--|--------------------------|---------------------------------|--|---|--|------------------------------------|-----------------------------|-------------------------------------|-------------|---------------------|
| | SERVICE SENSING PORT | | | | NORMALLY OPEN | NORMALLY CLOSED | LENGTH | OUTSIDE DIA. | AIR (2) | SENSING (3) | |
| | LIQUID OR GAS | OXYGEN GAS | | | | | | | | | |
| C | 28755-1 28755-2 28755-3 28755-8 | -11 -12 -13 -18 | 10,000 Standard 5000 Oxygen | 3-Way N.C. | | 1500 - 10,000 300 - 3500 150 - 700 800 - 9500 | 5-11/16 | 1-3/8 | 1/8" NPT (Vent not Threaded) | 1/4" NPT | |
| | 28791-1 28791-2 28791-3 28791-4 | -11 -12 -13 -14 | | (1) 2-Way N.O. | 2500 - 10,000 750 - 4000 250 - 750 2000 - 8500 | 6-1/8 | 1/4" NPT Out 1/8" NPT In | | | | |
| | 28974-24 28974-25 | N/A | | 3-Way N.C. 2-Way N.C. | | 6000 - 25,000 | 8 | | 1/8" NPT (Vent not Threaded) | | 1/4" Super-pressure |
| | 28974-59 28974-60 | N/A | | 3-Way N.C. 2-Way N.C. | | 20,000 - 60,000 | 8 | | 1/8" NPT (Vent not Threaded) | | |
| | 29074-25 29074-60 | N/A | 25,000 60,000 (Intermittent) | (1) 2-Way N.O. | 6000 - 25,000 20,000 - 60,000 | | 8 | 1/4" NPT Out 1/8" NPT In | | | |
| | 55230-1 55230-3 | -11 -13 | 600 | 3-Way N.C. | | 12 - 37 17 - 200 | 6-1/2 | 2-1/8 | 1/8" NPT (Vent not Threaded) | 1/4" NPT | |
| | 55416-1 55416-2 | -11 -12 | | Pipe either (1) 3-Way N.C. or 2-Way N.O. | 13 - 47 28 - 200 | 13 - 47 28 - 200 | 7 | | 1/4" NPT N.O. 1/8" NPT Others | | |
| | 56650-1 56650-2 | -11 -12 | 10,000 Standard 5000 Oxygen | 3-Way N.C. | | 50 - 180 110 - 900 | 6-5/16 | 1-3/8 | 1/8" NPT (Vent not Threaded) | | |

AIR OPERATED DIRECTIONAL CONTROL AND RELEASE VALVES

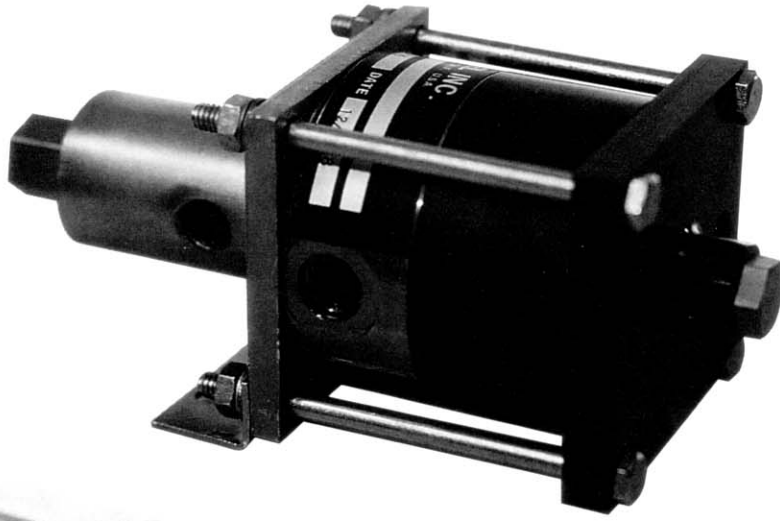

3-Way Release Valve
Model 50135



Release Valve
Model 28940-1



Release Valve
Model 53585



Release Valve
Model 54416

These directional control valves are basically a family with common characteristics and benefits.

- They are seated poppet or ball design for virtually zero leakage at high pressures with low viscosity fluids. They are not "bubble-tight" on gas.

Note: Normally open models will generally hold a tighter seal on low viscosity liquid or gas because seating force does not depend on inlet pressure.

- They are directly air-actuated for ideal system compatibility in wet or hazardous areas, or when used with air driven pumps or boosters. Yet, if electronic or electrical control is preferred, they can be actuated with any of the

wide selection of subminiature 3-way solenoid air valves available from many manufacturers.

- They employ the same basic area ratio principle used in Haskel pumps enabling high forces to be easily and directly controlled from low-pressure plant main or instrument air.
- Although not normally considered for pressure control, all of the normally open 2-way models can do double-duty in a circuit by also providing a safety relief function simply by installing a small air regulator in their pilot line (schematics next page).

AIR PILOTED VALVES — TYPICAL APPLICATIONS

50135 3-WAY NORMALLY CLOSED

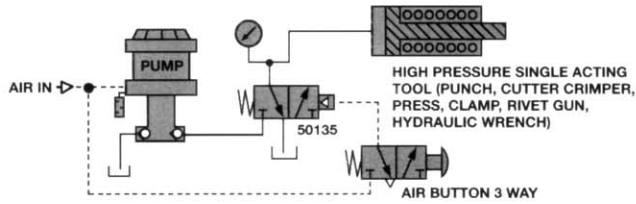

53430 3-WAY NORMALLY OPEN

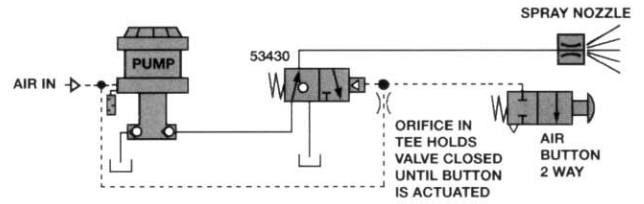

NOTES:

1. IF TOOL IS DOUBLE ACTING, ADD ANOTHER 50135 WITH AIR BUTTON IN PARALLEL.

2. IF ADDITIONAL TOOLS ARE TO BE POWERED OFF SAME PUMP, ADD VALVES IN PARALLEL WITH CHECK VALVE AT EACH INLET PORT.

28940 or 53581 2-WAY, NORMALLY CLOSED, 2-STAGE

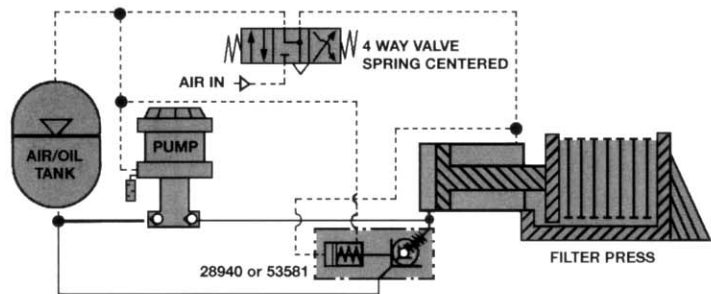

53585 2-WAY NORMALLY CLOSED

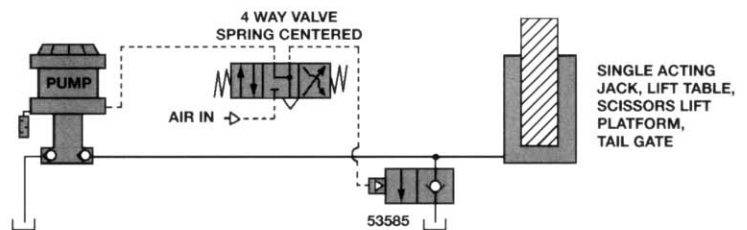

54416 or 54492 2-WAY NORMALLY OPEN

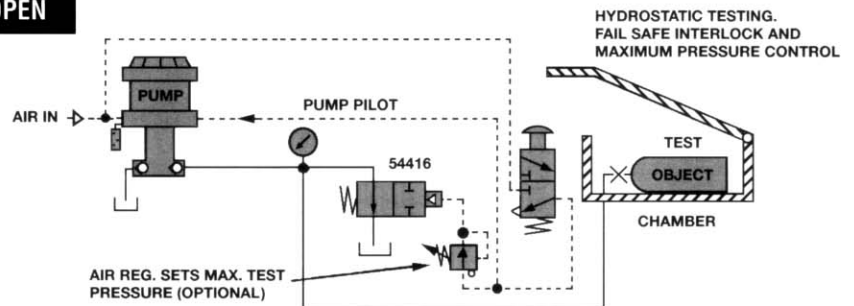

53560 2-WAY NORMALLY OPEN

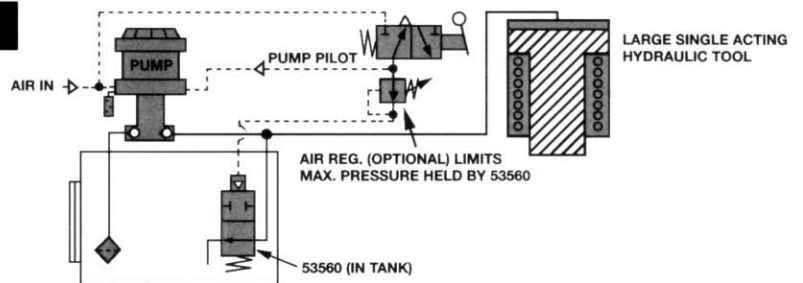

AIR PILOTED VALVES — SELECTION CHARTS

| TYPE | NORMAL POSITION | SCHEMATIC WITH APPROXIMATE WEIGHT AND SIZE | MODEL NUMBER | REMARKS | NOMINAL AREA RATIO FOR ACTUATION | MAXIMUM INLET WITH 100 PSIG AIR PILOT | CV (MIN.) | PORT SIZES AND MAXIMUM PRESSURES, PSI | | MATERIALS (LIQUID SECTION) |
|-------|-----------------|--|--------------|---|----------------------------------|---------------------------------------|---------------|---------------------------------------|--------------------------|--|
| | | | | | | | | P, C or B | T or A | |
| 3-WAY | Closed | <p>Weight: 5-3/4 lbs.</p> | 50135 | <ul style="list-style-type: none"> Closed crossover Dual C porting | 150:1 | | P to C .42 | 1/4" NPT 10,000 | 3/8" SAE Tube 3000 | Plated Steel, Polyurethane, Buna N |
| | | | 50135-1 | <ul style="list-style-type: none"> Same as above and includes manual override | 150:1 | 10,000 psi | C to T .64 | | | |
| | Open | <p>Weight: 1 lb.</p> | 53430-4 | <ul style="list-style-type: none"> Open crossover Rated for plain water | 85:1 | 8500 psi | .3 | 1/4" NPT 15,000 | 1/4" NPT 3000 | Stainless Steel, Buna N, PTFE |
| | | | 53430-5 | | 50:1 | 5000 psi | .6 | | | |
| | | | 53430-6 | | 40:1 | 4000 psi | .8 | | | |
| | | | 53430-7 | | 150:1 | 12,000 psi | .1 | | | |

| AIR PILOT PORTS: 150 PSI MAXIMUM ALL MODELS | SIZE | MODELS |
|---|----------|---------------------------------------|
| | 1/8" NPT | 54416, 53430, 53585, 28940, 53581 (C) |
| | 1/4" NPT | 50135, 53560, 53581 (D) |

| TYPE | NORMAL POSITION | SCHEMATIC WITH APPROXIMATE WEIGHT AND SIZE | MODEL NUMBER | REMARKS | NOMINAL AREA RATIO FOR ACTUATION | MAXIMUM INLET WITH 100 PSIG AIR PILOT | CV (MIN.) | PORT SIZES AND MAXIMUM PRESSURES, PSI | | MATERIALS (LIQUID SECTION) |
|-------|--------------------|---|--|--|--|---------------------------------------|------------------------------------|---------------------------------------|----------------------------------|---|
| | | | | | | | | P, C or B | T or A | |
| 2-WAY | Closed | <p>RELEASE VALVES MODELS 28940 and 28940-1 Weight: 2-3/4 lbs. MODELS 53581 - Weight: 5 lbs.</p> | 28940 | <ul style="list-style-type: none"> 2-stage decompression and release Rated for plain water | 250:1 (1st stage) 9:1 (2nd stage) | 15,000 psi | 1st stage - .1 2nd stage - 1.50 | 1/2" NPT 15,000 | 1/2" NPT 10,000 | Stainless Steel, Buna N, PTFE |
| | | 28940-1 | <ul style="list-style-type: none"> 2-stage decompression and release | | | | | | Plated Steel, Buna N, PTFE | |
| | | 53581 | | | 150:1 (1st stage) 12:1 (2nd stage) | 6000 psi | 1st stage - .4 2nd stage - 5.5 | 1" NPT 6000 | 3/4" NPT 500 | |
| | | 53585 | <p>RELEASE VALVE MODEL 53585 Weight: 1 lb.</p> | <ul style="list-style-type: none"> Single-stage release Rated for plain water | 110:1 | 10,000 psi | .1 | 1/4" NPT 10,000 | | |
| | | 54416 54492-1 | <p>RELEASE VALVE MODEL 54416 Weight: 1 lb.</p> | | 55:1 | 5000 psi | .6 | | | |
| | 54416-1 54492 | | <ul style="list-style-type: none"> Rated for plain water | 120:1 | 11,000 psi | .25 | 1/4" NPT 15,000 | | | |
| | 54416-2 54492-2 | | <ul style="list-style-type: none"> 54492 is needle type allowing flow in either direction | 160:1 | 15,000 psi | .15 | | | | Stainless Steel, Aluminum, Buna N |
| | 54416-3 | | | 90:1 | 7800 psi | .32 | | 1/4" NPT 3000 | | |
| | 54416-4 | | | 300:1 | 25,000 psi | .08 | 1/4" super-pressure 25,000 | | | |
| | Open | | <p>RELEASE VALVE MODEL 57175 - Weight: 5 lbs.</p> | 57175-30 | <ul style="list-style-type: none"> Rated for plain water Needle type allows flow in either direction | 600:1 | 30,000 psi | .15 | 1/4" super-pressure 30,000 | |
| | | <p>RELEASE VALVE MODEL 57175 - Weight: 5 lbs.</p> | 57175-60 | | 1200:1 | 60,000 psi | .09 | 1/4" super-pressure 60,000 | | |
| | | <p>RELEASE VALVE MODEL 53560 - Weight: 2 lbs.</p> | 53560-12 | <ul style="list-style-type: none"> Designed for mounting inside tank | 25:1 | 2500 psi | 5.5 | 1/2" NPT 3000 | | Plated Steel, Aluminum, Buna N |
| | | <p>RELEASE VALVE MODEL 53560 - Weight: 2 lbs.</p> | 53560-150 | | 160:1 | 15,000 psi | .85 | 1/4" NPT 15,000 | 5/8" Dia. Vent Hole ATM | |

REGULATING RELIEF VALVES

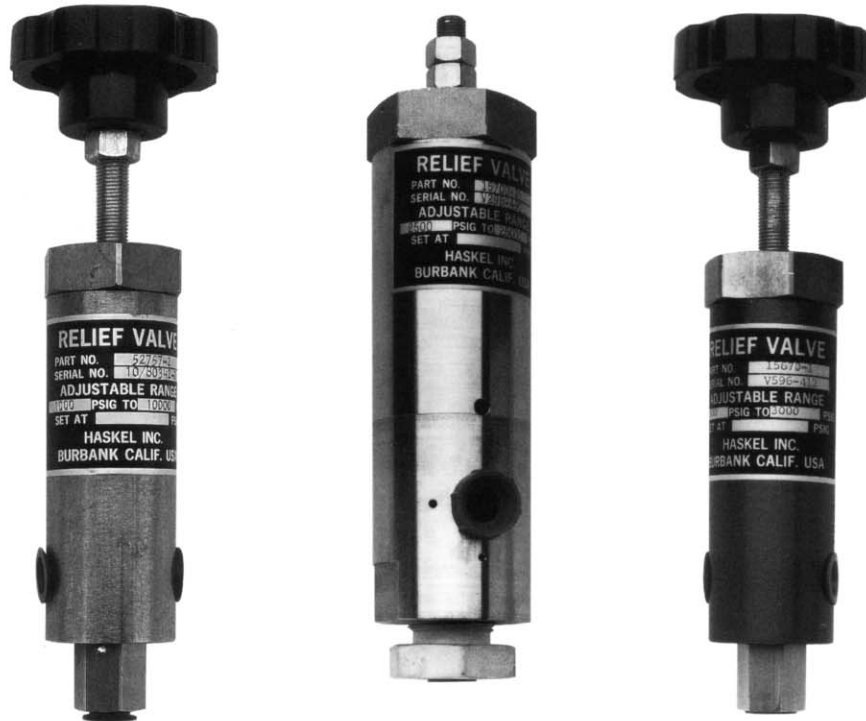

These valves were originally developed in response to the need for accurate regulation of high pressure at low flow without the “chatter” often encountered with valves of this size. They are differential area poppet design with a high ratio between seal and seat area for smooth control, repeatability and low deadband between crack and reseal pressure.

bubble tight, they do an excellent job holding high-pressure gas due to their precision poppet and hardened stainless steel seat with heavy silver plating.

Flow capacity is ultimately determined by the seat orifice and its CV rating as listed in the chart of models. The following curves show the typical effect of the .070" seat orifice as flow increases from the point at which the valve is set to relieve.

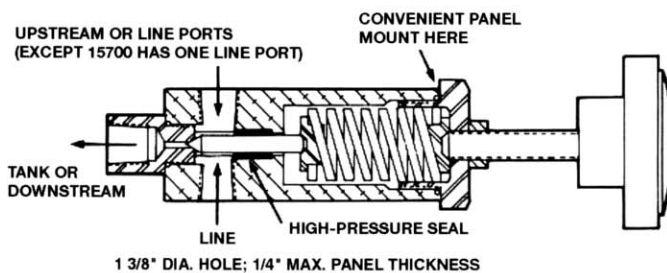

The configuration also makes the control settings virtually unaffected by downstream outlet pressure. This enables the valves to be also used for back pressure control (upstream pressure controller) or as a sequence (priority pressure) valve.

Materials of construction options seen in the chart of model numbers provide selections for most liquids including plain water plus most industrial gases including pure oxygen. Note that the nylon insert seat models are recommended for all gas applications below 10,000 psi. The 15700 series valves for service up to 60,000 psi are normally used as safety valves at these pressures. Although not rated as

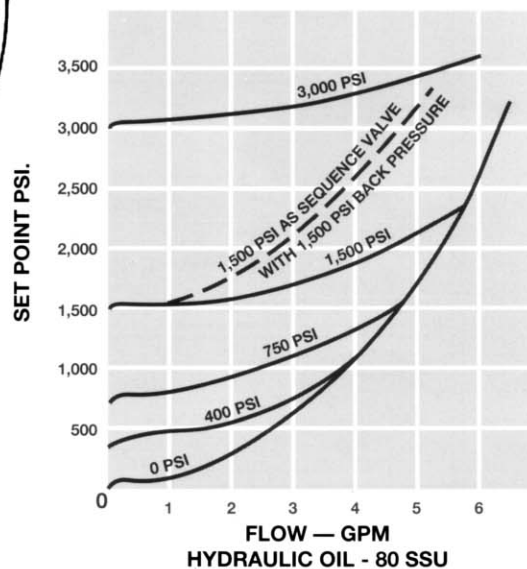

| MODEL NUMBER | SERVICE | PRESSURE RANGE | PORTS | | MATERIAL | | | ORIFICE DATA | |
|--------------|-------------|---------------------|------------|------------|-----------|-----------|------------|--------------|------|
| | | | PRESSURE | OUTLET | BODY | SEAT | SEAL | DIA. | CV |
| 15570-1 | Liquid | 300 - 3000 psi | 1/4" NPT | 1/4" NPT | Alum. | St. Steel | Buna-N | .070" | .12 |
| 15570-2 | Liquid | 600 - 6000 psi | 1/4" NPT | 1/4" NPT | Alum. | St. Steel | Buna-N | .070" | .12 |
| 15570-3 | Liquid | 1000 - 10,000 psi | 1/4" NPT | 1/4" NPT | Steel | St. Steel | Buna-N | .070" | .12 |
| 15670-1 | Gas or Liq. | 300 - 3000 psi | 1/4" NPT | 1/4" NPT | Alum. | Nylon | Buna-N | .070" | .12 |
| 15670-2 | Gas or Liq. | 600 - 6000 psi | 1/4" NPT | 1/4" NPT | Alum. | Nylon | Buna-N | .070" | .12 |
| 15900-1 | Gas or Liq. | 30 - 300 psi | 1/4" NPT | 1/4" NPT | Alum. | Nylon | Buna-N | .156" | .58 |
| 15900-2 | Gas or Liq. | 75 - 750 psi | 1/4" NPT | 1/4" NPT | Alum. | Nylon | Buna-N | .156" | .58 |
| 15901-1 | Liquid | 30 - 300 psi | 1/4" NPT | 1/4" NPT | Alum. | St. Steel | Buna-N | .296" | 2.09 |
| 15901-2 | Liquid | 75 - 750 psi | 1/4" NPT | 1/4" NPT | Alum. | St. Steel | Buna-N | .296" | 2.09 |
| 15960-1 | Liquid | 300 - 3000 psi | 3/8" NPT | 3/8" NPT | Alum. | St. Steel | Buna-N | .187" | .83 |
| 15960-2 | Liquid | 150 - 1500 psi | 3/8" NPT | 3/8" NPT | Alum. | St. Steel | Buna-N | .187" | .83 |
| 15700-25 | Liq./Gas ** | 2500 - 25,000 psi | 1/4" S.P.* | 1/4" NPT | St. Steel | St. Steel | Buna-N | .070" | .12 |
| 15700-26 | Liq./Gas ** | 2500 - 25,000 psi | 1/4" S.P.* | 1/4" S.P.* | St. Steel | St. Steel | Buna-N | .070" | .12 |
| 15700-60 | Liq./Gas ** | 10,000 - 60,000 psi | 1/4" S.P.* | 1/4" NPT | St. Steel | St. Steel | Buna-N | .070" | .12 |
| 27741-1 | Liquid | 300 - 3000 psi | 1/4" NPT | 1/4" NPT | St. Steel | St. Steel | Viton/PTFE | .070" | .12 |
| 27741-2 | Liquid | 1000 - 10,000 psi | 1/4" NPT | 1/4" NPT | St. Steel | St. Steel | Viton/PTFE | .070" | .12 |
| 27741-3 | Gas or Liq. | 300 - 3000 psi | 1/4" NPT | 1/4" NPT | St. Steel | Nylon | EPR/PTFE | .070" | .12 |
| 27741-4 | Gas or Liq. | 1000 - 10,000 psi | 1/4" NPT | 1/4" NPT | St. Steel | Nylon | EPR/PTFE | .070" | .12 |
| 27741-11 | Oxygen | 300 - 3000 psi | 1/4" NPT | 1/4" NPT | St. Steel | Nylon | Viton/PTFE | .070" | .12 |
| 27741-12 | Oxygen | 500 - 5000 psi | 1/4" NPT | 1/4" NPT | St. Steel | Nylon | Viton/PTFE | .070" | .12 |

* Superpressure ** Not bubble-tight on gas service

MODELS 15570, 15670, 15900, 15901 & 27741

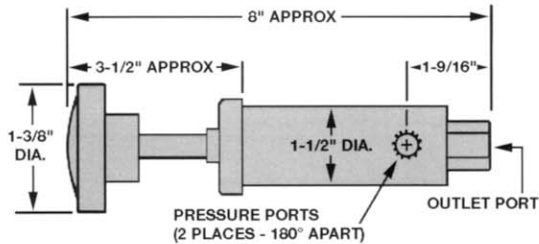

MODEL 15960

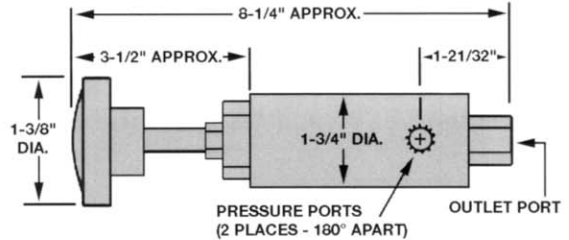

TO ORDER WITH ADJUSTING SCREW (NO KNOB)

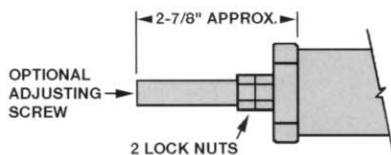

| FOR MODELS | ORDER |
|--------------------------|----------|
| 15570-1, 2, 3 | 27560-XX |
| 15670-2, 2 | 28440-XX |
| 27741-1, 2, 3, 4, 11, 12 | 28580-XX |

MODEL 15700

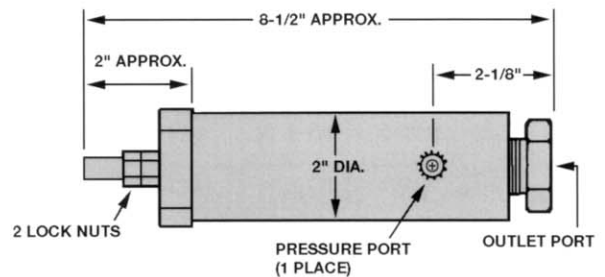

HYDRAULIC ACCUMULATORS AND GAS RECEIVERS

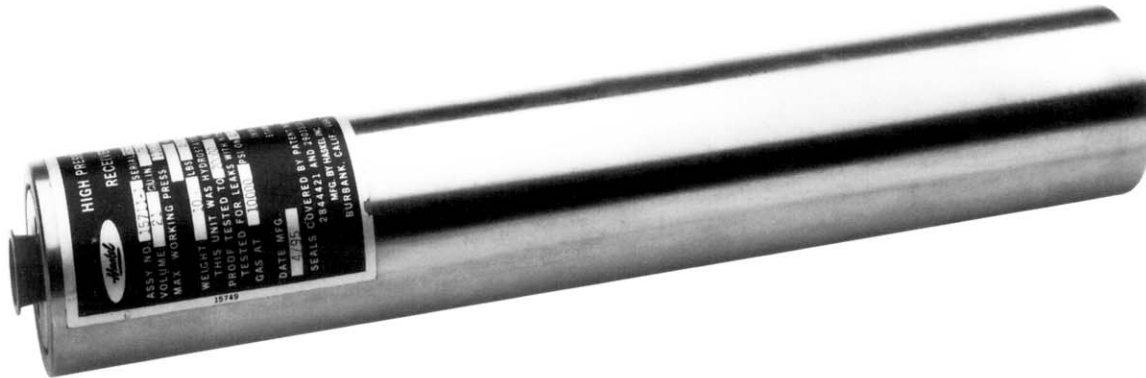

HYDRAULIC ACCUMULATORS

Hydraulic Accumulators for use with Haskel high-pressure hydraulic pumps. Will store large amounts of energy. Suitable for mineral base oils and DC-200 silicon oil. Suitable seals can be furnished on special order for phosphate-ester base liquids.

Each accumulator is proof tested to twice its maximum working pressure. To increase oil storage capacity, Haskel gas receivers can be connected to gas end of accumulators. Always precharge with nitrogen (not air).

Materials: Heat treated chromoly steel; barrel painted on outside, unplated inside; ends nickel plated; pistons are high-strength aluminum; seals are Buna-N with PTFE backups.

GAS RECEIVERS

Gas Receivers are designed for use with Haskel gas booster compressors and as backup gas storage for Haskel accumulators. Suitable for non-corrosive gases (helium, argon, nitrogen, etc.). Oxygen service on special order only, 5000 psi maximum. Not rated for hydrogen.

Each receiver is proof tested hydrostatically to twice its working pressure and tested for gas leakage at maximum working pressure. (This proof test exceeds both ASME and D.O.T.-3AA requirements.)

Since high-pressure gas storage vessels are critical and particularly susceptible to inside flaws, each barrel is carefully honed inside to remove all inclusions and flaws after magnetic inspection.

Materials: Heat treated chromoly steel; nickel plated inside and outside. Seals are Buna-N with PTFE backups.

NOTE: SINCE THESE ACCUMULATORS AND RECEIVERS ARE LESS THAN 6" O.D., ARE NOT WELDED AND DO NOT EXCEED 1/2 CU. FT. DISPLACEMENT, THEY DO NOT REQUIRE ASME CERTIFICATION.

| MAXIMUM WORKING PRESSURE (PSI) | ACCUMULATORS | | | RECEIVERS | | | OUTSIDE DIAMETER | LENGTH | SUPER-PRESSURE PORT SIZE* |
|--------------------------------|--------------|-------------|----------------|--------------|---------------------|----------------|------------------|---------|---------------------------|
| | MODEL NUMBER | OIL VOLUME | APPROX. WEIGHT | MODEL NUMBER | ACTUAL DISPLACEMENT | APPROX. WEIGHT | | | |
| 10,000 | 15801-1 | 366 cu. in. | 163 lbs. | 15542-1 | 443 cu. in. | 154 lbs. | 5-3/4" | 39" | 9/16" |
| | 15801-2 | 820 cu. in. | 270 lbs. | 15542-2 | 897 cu. in. | 261 lbs. | | 71" | |
| | 15806-1 | 185 cu. in. | 57 lbs. | 15706-1 | 210 cu. in. | 54 lbs. | 3-3/4" | 36" | 3/8" |
| | 15811-1 | 16 cu. in. | 11 lbs. | 15711-1 | 21 cu. in. | 10 lbs. | 2-3/8" | 13-1/8" | |
| | 15811-2 | 31 cu. in. | 14 lbs. | 15711-2 | 36 cu. in. | 13 lbs. | | 19-7/8" | |
| | | | | 15711-3 | 66 cu. in. | 22 lbs. | | 32-1/4" | |
| 20,000 | 15802-2 | 841 cu. in. | 449 lbs. | 15545-2 | 890 cu. in. | 444 lbs. | 5-3/4" | 94" | 9/16" |
| | 15807-1 | 122 cu. in. | 82 lbs. | 15707-1 | 134 cu. in. | 81 lbs. | 3-3/4" | 39" | 3/8" |
| | 15812-1 | 16 cu. in. | 13 lbs. | 15712-1 | 20 cu. in. | 13 lbs. | 2-3/8" | 14-3/4" | 1/4" |
| | 15812-2 | 31 cu. in. | 20 lbs. | 15712-2 | 35 cu. in. | 19 lbs. | | 23-1/4" | |
| | | | | 15712-3 | 65 cu. in. | 32 lbs. | | 40-1/4" | |

* Available with pipe thread – special order

Particle filters — 5 micron nominal

These units are designed as the final protection with gas boosters handling purified gases, or liquid pumps handling pre-filtered clean liquids. The elements do not have sufficient area to be practical for more than occasional particle migration due to pump wear or improperly cleaned piping or containers. They have proven to be good insurance particularly on high-pressure gas systems.

- Filtration: 5 micron nominal
- All stainless steel barstock
- Pressure drop:
 - 25 psi @ 3 gpm MIL-H-5606 oil across paper element.
 - 10 psi @ 100 scfm gas at 3000 psi across stainless steel element

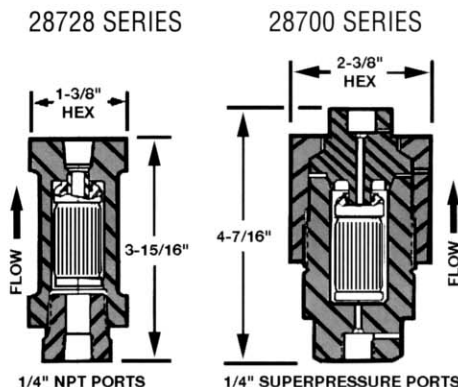
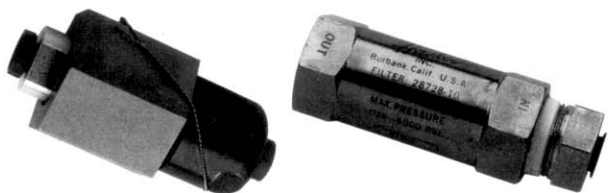

| MODEL NUMBER | SERVICE | MAXIMUM RATED OPERATING PRESSURE | ELEMENT |
|--------------|------------|----------------------------------|-----------|
| 28700-1 | Gas/Liquid | 30,000 psi | St. Steel |
| 28728-1 | Gas | 6000 psi | St. Steel |
| | Liquid | 8000 psi | |
| 28728-2 | Liquid | 8000 psi | Paper |
| 28728-10 | Oxygen | 5000 psi | St. Steel |

PLENUM CHAMBERS



SMALL TUBULAR ALL AISI 300 SERIES STAINLESS STEEL
Used in air amplifier and gas booster assemblies to dampen pulsation between stages.

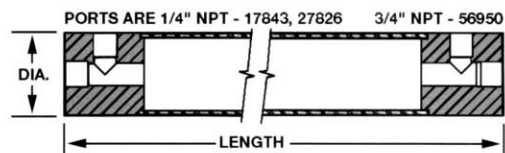

| MODEL NUMBER | VOLUME | WORKING PRESSURE | PROOF PRESSURE | LENGTH | DIAMETER | WEIGHT |
|--------------|-------------|------------------|----------------|--------|----------|---------|
| 17843 | 25 cu. in. | 1400 psi | 2800 psi | 20" | 1-1/2" | 4 lbs. |
| 27826 | 20 cu. in. | 5000 psi | 10,000 psi | 23" | 1-1/2" | 7 lbs. |
| 56950 | 100 cu. in. | 1250 psi | 2500 psi | 24" | 2-3/4" | 12 lbs. |

6000 PSI GAS STORAGE CYLINDER

- Manufactured and certified to DOT-E-9909-6000 specifications for 6000 psi gas at 70°F
- Actual volume: 2640 ACI (1.53 ACF).
- Capacities @ 6000 psi:
 - Air-509 SCF. N₂-494 SCF
 - AR-581 SCF. He-525 SCF
- One-piece forged and heat-treated alloy steel construction
- Primed and orange-yellow painted exterior with stainless steel port adapter
- Nominal dimensions: 9.28" O.D. x 52" high



| MODEL | PORT | WEIGHT |
|--------------|--------------------|----------|
| 13687-9-20SS | 3/8" MS16142-6 | 189 lbs. |
| 13687-9-80SS | 3/8" Superpressure | |
| 13687-9 | 3/4" NPT | |



Haskel International, Inc.
North America • South America
100 East Graham Place
Burbank, California 91502 • USA
Telephone: (818) 843-4000
Fax: (818) 556-2549 or (818) 841-4291

For further information on
Haskel products, visit our web-
site at: www.haskel.com

ACC-GL

Printed in USA.



Haskel Energy Systems Ltd.
Europe • Middle East
North Hylton Road
Sunderland SR5 3JD • England • UK
Tel: 44-191-549-1212 • Fax: 44-191-549-0911

Haskel (Asia) Pte. Ltd.
23 Tagore Lane #03-07
Tagore 23 Warehouse Complex
Singapore 787601
Tel: 65-6455-7559 • Fax: 65-6455-2841

Haskel Australasia Pty. Ltd.
P.O. Box 267
Salisbury, Qld. 4107, Australia
Tel: 61-7-3277-9118 • Fax: 61-7-3277-6129

Haskel HochdruckSysteme GmbH
D-46485 Wesel
Fritz-Haber Strasse • Germany
Tel: 49-281-98-48-00 • Fax: 49-281-98-48-020

Haskel-General Pneumatic
4 rue du haut de la Cruppe
F-59650 Villeneuve d'Ascq • France
Tel: 33-320-04 66 00 • Fax: 33-320-33 31 95

Haskel Benelux B.V.
Cobaltstraat 29
2718 RN Zoetermeer • Netherlands
Tel: 31-79-361 84 72 • Fax: 31-79-360 05 60

Haskel España S.R.L.
Paseo Urbarburu 81 • Edif.5 • 1ª Planta
Locales 1 y 2 • Pol. 27 Martutene
20115 Astigarraga • Gipuzkoa • Spain
Tel: 34-943-47 45 66 • Fax: 34-943-45 11 86

Haskel Energy Systems Limited
Unit 14, Airways Industrial Estate,
Pitmedden Road
Dyce, Aberdeen AB21 ODT • Scotland
Tel: 01224-771784 • Fax: 01224-723642

Haskel Italiana S.R.L.
via Varese 17/B
21013 Gallarate • Varese • Italy
Tel: 0039 0331 701133 • Fax: 0039 0331 701130