

**Operating Instructions  
for  
Viscosity Compensated  
Flow Meter / Monitor**

**Model: VKM**



## 1. Contents

---

1. Contents.....	2
2. Note .....	3
3. Instrument Inspection.....	3
4. Regulation Use .....	3
5. Operating Principle.....	4
6. Mechanical Connection.....	5
7. Electrical Connection .....	5
7.1. Switching Output VKM-1.. and VKM-3.....	5
7.2. Example for Contact Protective Measures.....	7
7.3. ADI-Evaluation Electronics VKM-7.. .....	7
7.4. Compact electronic VKM-8... .....	7
8. Use in hazardous area .....	9
8.1. ATEX contact ...F0... (only VKM-1... and VKM-3...)	11
8.2. ATEX reed contact 41R57** .....	11
9. Commissioning.....	18
9.1. General .....	18
9.2. Switching Output VKM-1.. and VKM-3.....	18
9.3. ADI-Electronic Analyser VKM-7.....	19
9.4. Compact electronic VKM-8... .....	19
10. Maintenance .....	20
11. Technical Information.....	21
12. Order Codes .....	23
13. Recommended Spare-Parts.....	25
14. Dimensions .....	25
15. EU Declaration of Conformance (VKM) .....	28
16. EU declaration of conformance (reed contact 41R57**)	29
17. Declaration of the Manufacturer (Ex RC...)	30
18. EC-Type Examination Certificate Magnetic reed switch Ex RC .....	31
19. IECEx certificate (Ex RC).....	34

### Manufactured and sold by:

KOBOLD Instruments Inc.  
1801 Parkway View Drive  
Pittsburgh PA 15205-1422  
Tel.: 412-788-2830  
Fax: 412-788-4980  
E-Mail: [info@koboldusa.com](mailto:info@koboldusa.com)  
Internet: [www.koboldusa.com](http://www.koboldusa.com)

---

## 2. Note

---

Please read these operating instructions before unpacking and putting the unit into operation. Follow the instructions precisely as described herein.

The devices are only to be used, maintained and serviced by persons familiar with these operating instructions and in accordance with local regulations applying to Health & Safety and prevention of accidents.

When used in machines, the measuring unit should be used only when the machines fulfil the EC-machine guidelines.

**as per PED 2014/68/EU**

In acc. with Article 4 Paragraph (3), "Sound Engineering Practice", of the PED 2014/68/EU no CE mark.

Diagram 8, Pipe, Group 1 dangerous fluids

---

## 3. Instrument Inspection

---

Instruments are inspected before shipping and sent out in perfect condition. Should damage to a device be visible, we recommend a thorough inspection of the delivery packaging. In case of damage, please inform your parcel service / forwarding agent immediately, since they are responsible for damages during transit.

**Scope of delivery:**

The standard delivery includes:

- Viscosity Compensated Flow Meter / Monitor model: VKM
- Operating Instructions

---

## 4. Regulation Use

---

Any use of the device, which exceeds the manufacturer's specification, may invalidate its warranty. Therefore, any resulting damage is not the responsibility of the manufacturer. The user assumes all risk for such usage.

The models VKM are used for measuring and monitoring of viscous liquid flows (max. 540 mm<sup>2</sup>/s). They are suitable for measuring clean and homogeneous fluids which are compatible with the instrument materials used.

If using higher viscosity media, large deviations will occur to the measured values.

Large dirt particles may impede the movement of the float and cause false alarm conditions.

Ferritic particles deposited on the float (with magnet) may lead to the same effects.

The instruments are provided as follows:

### **Flow measurement (only for Model VKM-2.. and VKM-3..)**

The actual flow rate may be read off the magnetically operated pointer indicator mounted on the instrument. The scale indicates the flow rate directly in litres per minute.

### **Limit Value Switches (only for Model VKM-1.. and VKM-3..)**

The instrument is fitted with one or two adjustable limit value switches for the monitoring of flow throughput values.

#### **Type of contacts:**

- N/O contact (standard)
- Changeover contact (standard)
- N/O (cCSAus)
- Changeover (cCSAus)

## **5. Operating Principle**

---

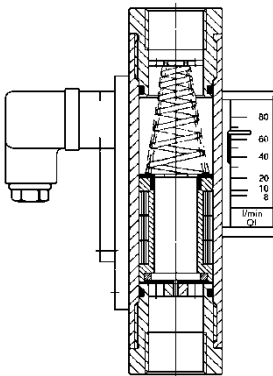

A hollow float with a sharp-edged orifice is located within a cylindrical bored metal housing. The flowing medium raises the float against the spring force. The position of the float corresponds to a particular flow rate which may be read from the needle indicator mounted on the instrument. Permanent magnets are fitted around the float which operates reed contact switches external to the flowing medium chamber.

The operation of the contacts is voltage free and works by means of magnetic force. i.e.: the contact is hermetically sealed from the flowing medium.

## 6. Mechanical Connection

### Before installation:

- It should be confirmed that the maximum allowed operating pressures and operating temperatures of the equipment are not exceeded.
- (see table: standard material combinations).
- The instruments may be mounted in any flow direction. No recalibration is required when changing position. The flow must always take place in the direction of the arrow (see label).
- Remove all transport packing and ascertain that no packing material is left in the instrument.
- Sealing of the connection threads should be carried out with Teflon tape or similar.
- The instruments must not be installed within an induction field.
- if possible, after the mechanical installation, it should be checked that the connection thread to pipe is fully sealed (see section 9).

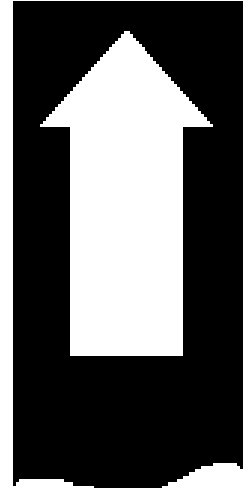

## 7. Electrical Connection

### 7.1. Switching Output VKM-1.. and VKM-3..

- Make sure that the supply wires are de-energized.
- Loosen the holding screw of the plug and pull out the cap from the socket.
- Make connection inside the plug-cap according to the wiring diagram.
- If the contact switch point has not been adjusted yet, it would be appropriate to do so at this point.
- (see section 9 Commissioning).
- Push the plug onto the socket, secure by using the locking screw. (see section 9 Commissioning).

N/O contact

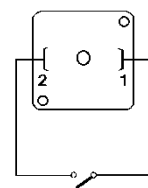

Changeover contact

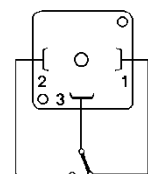

## Ex contact N/O

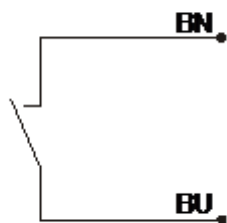

**Attention! The given electrical specifications of reed switches must never be exceeded, even for a short time. For higher switching capacities we recommend the use of contact protection relays (e.g. or model MSR) or any other contact protection device.**

After your designated external units are connected to the limit contact and adjustment of desired switching points is accomplished, then all the work regarding connections is completed.

The unit can now be set in operation.

## 7.2. Example for Contact Protective Measures

For capacitive and inductive loads (long cables and relay/protection) we recommend the following protective schemes.

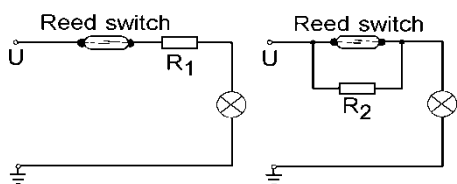

Lamp load with parallel or series resistance to the switch.

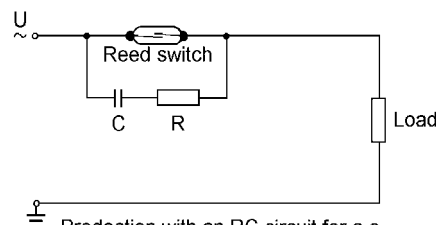

Protection with an RC circuit for a.c. current and inductive load.

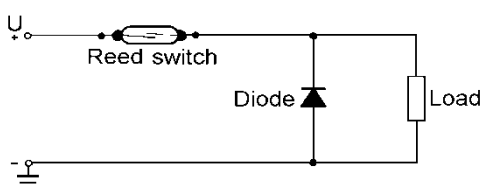

Protection with an idle diode for d.c. current and inductive load.

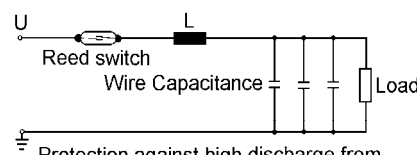

Protection against high discharge from condensers and loadcapacitances.

## 7.3. ADI-Evaluation Electronics VKM-7..

For connection of the power supply and the output signals please check with the operating instructions of the corresponding ADI electronic.



**Information!** The measuring input of the ADI is already factory-set.

## 7.4. Compact electronic VKM-8...

Compact electronic: (..C30R, ..C30M)

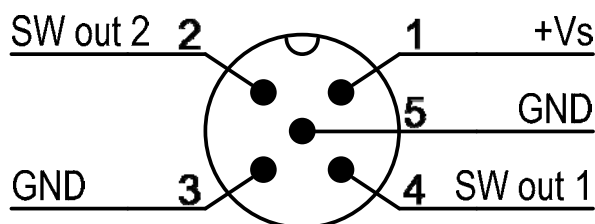

## Compact electronic: (..C34P, .. C34N)

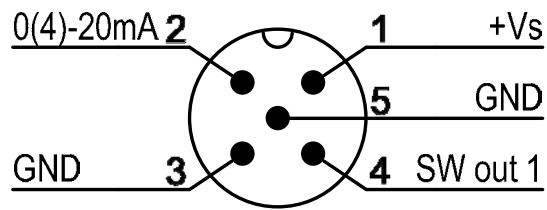



## 8. Use in hazardous area

Erklärung für Betriebsmittel ohne eigene potentielle Zündquelle in Anlehnung an die Richtlinie 2014/34/EU

TFR 18 HEK\_BopZ 0005 Edition 2

Seite 1 von 2

Statement an apparatus not containing an own potential source following Directive 2014/34/EU

TFR 18 HEK\_BopZ 0005 Edition 2

Page 1 of 2

Hiermit erklärt die / *hereby declares*

**KOBOLD Messring GmbH, Nordring 22-24, DE 65719 Hofheim**

in alleiniger Verantwortung, dass die Ergebnisse, der an den folgenden mechanischen Betriebsmitteln vorgenommenen Prüfungen, die Anforderungen der Richtlinie 2014/34/EU erfüllen.

*under the sole responsibility, that the results of the examinations with the mechanical equipment described below comply with the requirements of Directive 2014/34/EU.*

**Viskositätskompensierten Schwebekörper-Durchflussmesser / -wächter VKM (siehe auch Seite 2), Identifikations-Nummer siehe Lieferunterlagen**

**Vicosity Compensated Flowmeter / switch of the series VKM (see also at page 2), Identification number see shipping documents**

sind gemäß Richtlinie 2014/34/EU, Artikel 1

- a) keine Geräte,
- b) keine Schutzsysteme,
- c) keine Sicherheits-, Kontroll- oder Regeleinrichtungen,
- d) keine Komponenten.

*are according to Directive 2014/34/EU, article 1*

- a) not an equipment,*
- b) not a protective system*
- c) not a safety device, controlling device or regulating device*
- d) not a component.*

Die mechanischen Betriebsmittel haben bei bestimmungsgemäßem Betrieb keine eigene potentielle Zündquelle und bekommen **keine Kennzeichnung** im Sinne der ATEX-Richtlinie. Eine interne Zündgefahrenbewertung wurde durchgeführt. Als Medium wird ein Fluid verwendet.

*When used adequately, this mechanical equipment has no inherent potential ignition source and thus it is **not marked** in accordance with the ATEX-Directive. An internal ignition risk analysis was carried out. The used medium is a fluid.*

Die mechanischen Betriebsmittel können, unter Berücksichtigung der geltenden Einrichtungsbestimmungen für Maschinen, Geräte und Anlagen im Ex-Bereich, z.B. EN 1127-1, EN 60079-14 u.a., folgendermaßen eingesetzt werden:

*The apparatus can be used as follows in explosive atmospheres in accordance with the applicable erection regulations on machines, devices and plants, such as e.g. EN 1127-1, EN 60079-14, etc.:*

- a) In der Zone 1 (Gas-Ex, Kategorie 2G, EPL Gb) in den Explosionsgruppen IIA, IIB und IIC
- b) In der Zone 2 (Gas-Ex, Kategorie 3G, EPL Gc) in den Explosionsgruppen IIA, IIB und IIC
- c) In der Zone 21 (Staub-Ex, Kategorie 2D, EPL Db) in den Explosionsgruppen IIIA und IIIB
- d) In der Zone 22 (Staub-Ex, Kategorie 3D, EPL Dc) in den Explosionsgruppen IIIA und IIIB

- a) In Zone 1 (gas hazard, category 2G, EPL Gb) in the explosion groups IIA, IIB and IIC*
- b) In Zone 2 (gas hazard, category 3G, EPL Gc) in the explosion groups IIA, IIB and IIC*
- c) In Zone 21 (dust hazard, category 2D, EPL Db) in the explosion groups IIIA und IIIB*
- d) In Zone 22 (dust hazard, category 3D, EPL Dc) in the explosion groups IIIA und IIIB*

Mögliche elektrische Betriebsmittel sind ohne Einfluss auf den mechanischen Zündschutz. Sie müssen den Anforderungen der jeweils vor Ort herrschenden Zonen genügen und sind nicht Bestandteil dieser Erklärung

*Any electrical apparatus that may be used here do not impair the mechanical explosion protection. Those apparatus have to comply with the locally applicable zones and are not subject of this statement.*

Folgende harmonisierte Normen/Spezifikationen sind in der am Unterschriftsdatum aktuellen Fassung angewandt worden:

*The following harmonised standards and specifications were referred to in their version applicable on the date of signature:*

- EN 1127-1 Explosionsfähige Atmosphären, Explosionsschutz, Teil 1: Grundlagen und Methodik

- EN 1127-1 Explosive atmospheres, Explosion prevention and protection, Part 1: Basic concepts and methodology

Wichtige Hinweise:

*Please note:*

- a) Die vom Hersteller erstellten Einbau und Bedienungsanleitungen sind zwingend zu beachten.
- b) Die im Anwenderland geltenden Errichtungsbestimmungen sind zu beachten.
- c) Die mechanischen Komponenten der VKM-Baureihe sind für Umgebungstemperaturen von:  
mit Perbunan-Dichtung -20 °C .. 70 °C  
mit Viton-Dichtung -10 °C .. 100 °C geeignet.

- a) The installation and operating instructions provided by the manufacturer are to be considered compellingly.*
- b) The installation regulations valid in the designated country of use are to be observed.*
- c) The VKM series with its mechanical components is suitable for ambient temperatures of  
with Perbunan-seal -20 °C .. 70 °C  
with Viton-seal -10 °C .. 100 °C.*

## Erklärung für Betriebsmittel ohne eigene potentielle Zündquelle in Anlehnung an die Richtlinie 2014/34/EU

TFR 18 HEK\_BopZ 0005 Edition 2

Seite 2 von 2

## Statement an apparatus not containing an own potential source following Directive 2014/34/EU

TFR 18 HEK\_BopZ 0005 Edition 2

Page 2 of 2

- d) Bei bestimmungsgemäßem Betrieb wird außen eine Erwärmung < 10 K erwartet; die Temperaturklasse T4 wird eingehalten.
- e) Die Geräte können elektrostatisch aufgeladen werden. Es sind geeignete Maßnahmen - elektrostatisch erden, „nur feucht reinigen“ und Aufladungsprozesse vermeiden - einzuhalten, um eine Gefährdung auszuschließen. Eine Warnkennzeichnung ist beispielhaft auf verschiedenen Geräten angebracht. 
- f) Sämtliche außen liegenden Werkstoffe bestehen aus geeigneten funkenarmen Materialien, kein Leichtmetall. Der Betreiber ist jedoch für die Überprüfung der Zündgefahr durch Funken beim Betrieb der kompletten Maschine selbst verantwortlich.
- g) Die mechanischen Komponenten des VKM müssen in den Potentialausgleich einbezogen werden.
- h) Anschlussleitungen von elektrischen Betriebsmitteln sind geschützt zu verlegen.
- i) An Bauteilen dürfen in der Explosionsgruppe IIC und der Zone 1 keine projizierten Oberflächen von Kunststoffen > 20 cm<sup>2</sup> vorhanden sein; bei IIB oder im Staub dürfen 100 cm<sup>2</sup> erreicht werden. Die Geräte dürfen nicht dort eingesetzt werden, wo damit zu rechnen ist, dass dort starke elektrostatische Aufladungen (Gleitstielbüschelentladungen) provoziert werden (durch menschliche Aufladung nicht möglich)
- j) Wenn isolierende Anschlussschläuche verwendet werden, dann sind Typen mit einem Durchmesser < 20 mm (IIC) oder < 30 mm (IIA, IIB, Staub) zulässig.
- k) Staubablagerungen sind regelmäßig zu entfernen.
- l) Bei Undichtigkeit des Gehäuses darf das Betriebsmittel nicht weiter betrieben werden
- m) Die Verwendung von brennbarem oder explosionsfähigem Medien ist nicht zulässig.
- n) Streuströme (z.B. in Anlagen mit elektrischem Korrosionsschutz) dürfen nicht über die Bauteile geführt werden
- o) Bei Montagen im Ex-Bereich ist unbedingt die EN 1127-1 Anhang A zu beachten (ggf. funkenarmes Werkzeug benutzen!)

- d) *At intended operation the temperature rising outside is < 10 K; Temperature class T4 is kept.*
- e) *The apparatus is electrostatically chargeable. Thus appropriate measures have to be taken – grounded electrostatically, “only cleaning with a damp cloth” and avoiding charging processes – that will prevent hazards. Warning signs are fixed exemplary on the outside of some apparatus.* 
- f) *All exterior materials consist of suitable low-sparking components no alloy. The operator himself, however, is responsible for checking the risk of ignition caused by sparks during the operation of the complete machine.*
- g) *The mechanical components of the VKM have to be integrated in the equipotential bonding.*
- h) *Connecting cables of electrical apparatus have to be installed in a protected manner.*
- i) *At apparatus in explosion group IIC and in Zone 1 no projected surfaces of plastics are permitted that exceed 20 cm<sup>2</sup>; in IIB or dust hazardous atmospheres 100 cm<sup>2</sup> may be reached. The products should not be used where strong electrostatic charges are present which provokes propagating brush discharges (by human charging it is not possible).*
- j) *If insulated connection hoses are used, only types with a diameter < 20 mm (IIC) or < 30 mm (IIA, IIB, Dust) may be used.*
- k) *Dust deposits are to be removed regularly.*
- l) *If the enclosure shows signs of leakage, the apparatus may be not operated further.*
- m) *The use of any flammable or explosive flow medium is not permitted.*
- n) *Leakage currents (e.g. in plants with electrical anti-corrosion protection) may not be led over the parts.*
- o) *When mounting the apparatus inside an explosive area, Annex A of standard EN 1127-1 has to be adhered to (if necessary, low-sparking tools have to be used).*

Ausgefertigt in Hofheim am 26. Februar 2018  
 Unterzeichnet für und im Namen der KOBOLD Messring GmbH

Ort und Datum

  
 Manfred Wenzel Prokurist / authorized signatory

Issued at Hofheim on February 26<sup>th</sup>, 2018  
 Signed for and on behalf of KOBOLD Messring GmbH

HEK\_18 BopZ 0005 Ed 2 Kobold VKM.odt

Folgende VKM-Betriebsmittel wurden in die Bewertung einbezogen / The following VKM series was considered for the assessment:

### Typenschlüssel Serie VKM / Type key series VKM

VKM-1***	Das Magnetfeld betätigt eine außerhalb angebrachten Kontakt	The magnetic field actuates an external contact
VKM-2***	Das Magnetfeld betätigt eine außerhalb angebrachte Anzeigevorrichtung	The magnetic field actuates an externally applied display device
VKM-3***	Das Magnetfeld betätigt eine außerhalb angebrachte Anzeigevorrichtung und einen zusätzlichen Kontakt.	The magnetic field actuates an externally applied display device and an additional contact.

**8.1. ATEX contact ...F0... (only VKM-1... and VKM-3...)**

II 2G Ex mb IIC T6 Gb

II 2 D Ex mb IIC T80 °C Db  
max. 250 V<sub>AC</sub>/1.5 A/100 VA**8.2. ATEX reed contact 41R57\*\***

ATEX N/O contact 41R57



II 3G Ex ic IIC T4 Gc



II 3 D Ex ic IIIC T125 °C Dc

-20 °C ≤ T<sub>a</sub> ≤ 80 °Cmax. 250 V<sub>AC/DC</sub>/1.5 A/100 W/100 VA

ATEX changeover contact 41R57U



II 3G Ex ic IIC T4 Gc



II 3 D Ex ic IIIC T125 °C Dc

-20 °C ≤ T<sub>a</sub> ≤ 80 °Cmax. 250 V<sub>AC/DC</sub>/1 A/30 W/60 VA

## Ex-relevant excerpt of the operating instructions of the reed contact 41R57 \*\*

### 1. Preamblel

This excerpt of the operating instructions only represents the ex-relevant aspects. It is copied into the original operating manual in the same or analogous form; Textual changes are permitted, the ex-relevant statements remain.

To ensure the function and for your own safety, please read the enclosed operating instructions carefully before you begin the installation. If you have any questions, please contact the KOBOLD Messring GmbH, Hofheim. It applies with the original operating instructions.

The following standard issues were considered in the evaluation of the product:

- a) IEC 60079-0:2017 Ed. 7 / EN 60079-0:2018 Explosive atmospheres – Part 0: Equipment - General requirements
- b) IEC 60079-11:2011 Ed. 6 + Corr. 2012 / EN 60079-11:2012 Explosive atmospheres - Part 11: Equipment protection by intrinsic safety "i"

### 2. General information on explosion protection

The reeds switches work together with various KOBOLD products and serve there for monitoring. It is available as N/O contact or changeover contact.

The electrical connection is made via a plug - only in intrinsically safe systems.

The reed switch is intended for commercial use and may only be used in accordance with the specifications in the technical documentation of Kobold and the information on the nameplate. It is only operated together with certified products via an intrinsically safe circuit. They comply with the valid standards and regulations.

The installation regulations (e.g. EN 60079-14) for systems in potentially explosive atmospheres must be observed.

Further important details can be found in the corresponding EC-type examination certificate.

### Permitted use

- The intrinsically safe reed switch can be used as follows:
  - In Zone 2 (Gas-Ex, EPL Gc) in explosion groups IIA, IIB and IIC
  - In Zone 22 (Dust-Ex, EPL Dc) in explosion groups IIIA, IIIB and IIIC
- The requirements for simple electrical equipment for use in intrinsically safe circuits in zones 1/21 are fulfilled.
- The qualification regarding the surface temperature is T4. For all gases, vapors, mists with an ignition temperature > 135 ° C the equipment is not an ignition source.
  - In the dust Ex area, 125 ° C is the reference temperature for further consideration regarding the safety distance from the smoldering temperature.
- The ambient temperature range is -20 ° C ≤ Ta ≤ 80 ° C.

## 2.1. Electrical characteristics for Ex i

Electrical data:

- Rated voltage up to 45 volt AC / DC
- Rated current up to 2 A
- $U_{iIC} \leq 30$  V AC / DC,  $I_{iIC} \leq 250$  mA
- $U_{iIB} \leq 45$  V AC / DC,  $I_{iB} \leq 2$  A
- $U_{iIIC} \leq 45$  V AC / DC,  $I_{iIIC} \leq 250$  mA
- $I_i =$  negligible,  $C_i =$  negligible
- Heating on the outer housing  $<15$  K

## 2.2 Type code

The equipment is identified by the following type code:

Type	Description	Item-No.	Remarks
41R57 A B	Type coding		
41R57	Contact device		
A	N/O contact (2 wires), Plug with black cap		
	Change-over contact (3 wires), Plug with grey cap		
B	70 – 75 with marking (not ex-relevant)	202.289	N/O
	45 – 50 with marking	202.285	N/O
	50 – 55 with marking	202.286	N/O
	60 – 65 with marking	202.287	N/O
	70 – 75 with marking	202.288	Change-over
	60 – 65 change-over contact	202.290	Change-over

## 2.3 Temperature class

The reed switch is suitable for temperature class T4 / T125 ° C.

## 2.4 General requirements

### 2.4.1 Intended Use

- a) To ensure safe operation, the products may only be used according to the instructions in the assembly instructions. During use, the legal and safety regulations required for the respective application must be observed in addition. This applies analogously when using accessories.
- b) Failure to comply with the instructions given in this excerpt or in the case of improper handling of the product will render our liability null and void. In addition, the warranty on products and spare parts is void.
- c) The products are not safety elements in terms of their intended use.
- d) Only original parts of the manufacturer may be used.

## 2.4.2 General safety instructions

The reed switch corresponds to the state of the art and is reliable. The reed switch may pose a residual hazard if improperly used and operated by untrained personnel.

Every person responsible for the installation, commissioning, maintenance or repairing of the reed switch must have read and understood the assembly instructions and in particular the safety instructions.

- a) Follow the general rules of technology for the selection and proper operation of a product.
- b) All connected electrical and mechanical equipment must be suitable for the respective application.
- c) Observe the notes in these operating instructions as well as the conditions of use and permissible data that appear from the imprints / nameplates of the respective products.
- d) It must be ensured that only product protection types corresponding to the zones are installed!
- e) The product is only approved for proper and intended use in a normal industrial atmosphere. Immersion in liquids is not permitted.
- f) It must be ensured that no falling objects can hit the product.
- g) The operator must ensure the lightning protection for the entire system in accordance with local regulations.
- h) It is the responsibility of the installer to ensure that the function of the reed switch in conjunction with the individual evaluation devices functions properly and is approved for the intended use.
- i) The intrinsically safe connection - including the reed switches - must be made via approved / tested evaluation devices, which may need to be equipped with suitable zener barriers or switching amplifiers.

## 3. Commissioning, installation

Depending on the IP degree of protection, the time for cleaning the equipment (dust deposits) must be specified. Other important facts:

- a) The product may be put into operation in Zone 2 (Cat. 3G, EPL Gc) or in Zone 22 (Cat. 3D, EPL Dc in intrinsically safe circuits only by specialists with a qualification similar to a qualified person according to TRBS 1203.
- b) The requirements for simple electrical equipment that apply to the hazardous area of Zones 1/21 according to EN 60079-11 are fulfilled.
- c) The products may only be used in the usual industrial atmosphere. In the presence of aggressive substances in the air, the manufacturer must always be consulted. The products must be adequately protected in adverse environmental conditions.
- d) Operation of the product is only permitted in fully assembled and undamaged enclosures. In case of possible damage, a zone carryover may have to be considered by the operator; Moreover, operation of the housing is not permitted if the housing is damaged.
- e) The environmental conditions specified in the operating instructions must be adhered to and protected against adverse environmental conditions.

- f) Heat radiation from foreign products / components must also be considered.
- g) The reed switch must be protected against inadmissible access of liquids and / or soiling.
- h) Fixed parts (e.g. due to frost or corrosion) must not be loosened by force in the presence of an explosive atmosphere. Icing must therefore be avoided.
- i) The reed switch may only be subjected to minor vibrations, see also IEC 34-14.
- j) To ensure the discharge of electrostatic charges, the national requirements must be considered.
- k) In particular, isolated capacities must be prevented.
- l) Only those zener barriers or switching amplifiers may be used whose output circuits are approved / tested for use in potentially explosive atmospheres. In Europe, use in Zones 1/21 requires an EC type-examination certificate for the equipment concerned issued by a body designated for explosion protection.
- m) The voltage of the supply units must be less than or equal to the voltage  $U_i$  of the reed switch.
- n) The total current  $I_o$  of the supply units must be less than or equal to the current  $I_i$  of the reed switch.
- o) For the installation of the intrinsically safe circuit, a control drawing (system description) to be created by the installer / operator is required.
- p) Equipotential bonding must be established along the intrinsically safe circuit when using a grounded supply.
- q) The certificates must be taken into account, including the special conditions specified therein.
- r) Resistant parts of the product (e.g. due to frost or corrosion) must not be forcibly loosened in the presence of an explosive atmosphere.
- s) Within the potentially explosive area, installation may only be carried out taking into account the locally applicable installation regulations. The following conditions must be observed (incomplete):
- t) Installation and maintenance may only be carried out in an explosion-free atmosphere and in compliance with the regulations in force in the country of the operator.
- u) Additional precautions must be taken if the presence of hydrogen sulphide, ethylene oxide and / or carbon monoxide is to be expected: these substances have very low ignition energy!
- v) In the presence of these substances and in the presence of a substance of the explosion group IIC and in the case of presumably existing potentially explosive atmosphere, only spark-free tools may be used!

## 4. Maintenance, servicing

Definition of terms according to IEC 60079-17:

**Maintenance and Repair:** A combination of all activities performed to maintain or recover an item in a condition that meets the requirements of the specification in question and ensures the performance of the required functions.

**Inspection:** An activity involving the careful examination of an object, with the aim of obtaining a reliable statement of the condition of the object, carried out without disassembly or, if necessary, with partial disassembly, supplemented by measures such as measurements becomes.

**Visual inspection:** A visual inspection is a test that detects visible faults, such as missing screws, without the use of access devices or tools.

**Close-up Test:** A test that identifies, in addition to the aspects of visual inspection, such errors, such as loose screws, which can only be obtained by using access devices, such as a screwdriver, e.g. steps (if necessary), and tools are visible. For close-up tests, housing usually does not need to be opened or the equipment must be de-energized.

**Detail test:** A test that detects, in addition to the aspects of close-up testing, such defects as, for example, loose connections that can only be recognized by opening housings and / or, if necessary, using tools and test equipment.

- a) Maintenance measures may only be carried out by qualified persons.
- b) Only use accessories in potentially explosive atmospheres that comply with all requirements of European directives and national legislation.
- c) Maintenance measures with dismantling of the reed switch may only be carried out in an ex-free atmosphere.
- d) The replacement of components may only be carried out with original spare parts, which are also approved for use in potentially explosive areas.
- e) The products must be regularly maintained and cleaned in the Ex area. The intervals are set by the operator according to the environmental demands on site.



	Activity	visual inspection per month	Close inspection every 6 months	detailed inspection every 12 months
1	Visual inspection of the reed switch for damage, remove dust deposits	•		
2	Check for integrity and function			•
3	Testing the entire system	The responsibility of the operator		

### 5. Troubleshooting

Products operated in conjunction with potentially explosive atmospheres must not be modified. Repairs to the product may only be performed by specially trained and authorized personnel.

### 6. Disposal

Disposal of the packaging and used parts must be in accordance with the regulations of the country in which the product is installed.

### 7. Marking of the reed switch (nameplate)

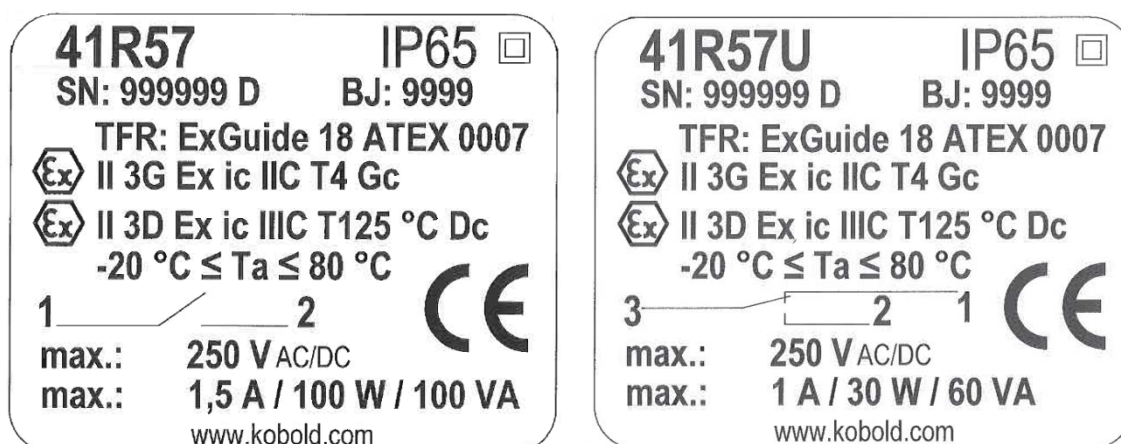

In the serial number the year of manufacture can be coded; optionally, it can also be specified as plain text.

As a rule, a readable marking has been made for the type of explosion protection required in field use - even before the product is put into operation for the first time.

A reed switch that has already been operated in non-intrinsically safe circuits may no longer be used in intrinsically safe circuits later on.

## 9. Commissioning

---

### 9.1. General

#### Over-ranging

The flow range may be exceeded by a large margin with a non-pulsating flow. Only a certain increase in pressure loss is experienced. (The permissible maximum operating pressure must not be exceeded!).

#### Viscosity range

The instrument scale is suitable for a viscosity range of 1 - 540 mm<sup>2</sup>/s. Within this range there is no need for recalibration.

### 9.2. Switching Output VKM-1.. and VKM-3..

#### Hysteresis (VKM-1.. and VKM-3..)

Hysteresis is characterised by the difference between the switching on and switching off points of the contact. By matching the magnet and reed contact strength (AW Number) a hysteresis of approx. 3.5 mm of float movement is achieved. At the same time it may be assured that the contacts have a bistable switching characteristic.

#### Adjustment of the limit values (VKM-1..)

- Loosen the mounting screws on the contact.
- Position the marking on the contact in line with the required value on the housing scale.
- Tighten the mounting screws at this position.

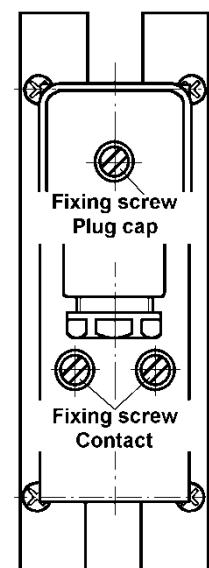

**Adjustment of the limit values (VKM-3..)**

- With a screwdriver, loosen both mounting screws at the contact.
- Move the switch housing to the lowest position.
- After loosening the screws, remove the plug cap from the contact.
- Connect a suitable multimeter to PIN 1 & 2 (SPDT: contact PIN 2 & 3); (see page 5).
- When the instrument is already installed, open the inlet pipe and slowly allow the medium to flow until the pointer indicator shows the required minimum flow throughput. The reed switch is then closed (electrical continuity).
- Move the switch housing upwards until the reed switch just opens (no electrical continuity).
- At this position tighten the mounting screws. Replace the plug cap. The instrument is now ready for operation.
- By correct adjustment of the limit switch, a bi-stable switch condition is achieved, i.e.: even when exceeding the adjusted limit value, the contact remains closed (PIN 1 + 2 or PIN 2 + 3 for changeover contact option).

**9.3. ADI-Electronic Analyser VKM-7..**

For adjusting the output parameters (analogue-, switching output) please check with the operating instruction of the corresponding ADI-electronic. The electronic of the ADI is already factory-set to the sensor.

**9.4. Compact electronic VKM-8..**

see Operating instructions supplement  
for compact electronics without frequency output.

## 10. Maintenance

---

In cases where the medium to be measured is uncontaminated, the models VKM are almost maintenance-free. However where calcium or dirt deposits form in the housing or other internal parts, the instruments should be regularly cleaned.

With a suitable open-ended spanner, remove the instrument from the pipe. After removal of the uppermost threaded connection, the internal parts may be removed for cleaning. The internal parts can be cleaned with a suitable brush. After cleaning reassemble the instrument in the correct order of assembly.

Please note that the spring must be installed into the nipple of the upper threaded connection and onto the float body. The lower end of the float with the inserted orifice is located at the fluid inlet side.

## 11. Technical Information

Body:	VKM-x1...: Brass, nickel-plated VKM-x2...: Stainless steel 1.4301
Screwed fitting:	VKM-x1...: Brass, nickel-plated VKM-x2...: Stainless steel 1.4301
Float:	VKM-x1...: Brass, nickel-plated VKM-x2...: Stainless steel 1.4301
Orifice:	stainless steel 1.4310
Spring:	stainless steel 1.4310
Magnet:	oxide ceramics
Seals:	VKM-x1...: NBR VKM-x2...: FPM
Max. temperature:	+100 °C (Attention! Restriction on hazardous area. See chapter 8)
Max. pressure:	VKM-x1...: 250 bar VKM-x2...: 350 bar
Installation position:	any
Basic accuracy:	±4% f. s. (with a viscosity of 105 mm <sup>2</sup> /s)
Measuring error due to change in viscosity:	For changes in viscosity within 1–540 mm <sup>2</sup> /s the additional deviation is ± 5% f. s. maximum
Viscosity range:	1–540 mm <sup>2</sup> /s VKM-xx01 (70...400 mm <sup>2</sup> /s)

### Contacts

#### Optional with VKM-1..., VKM-3... without ATEX

Electrical connection:	valve connector DIN EN 175301-803
Electrical switching values:	N/O contact max. 250 V <sub>AC/DC</sub> / 1.5 A / 100 W / 100 VA changeover contact max. 250 V <sub>AC/DC</sub> / 1 A / 30 W / 60 VA N/O contact and changeover contact (cCSAus) max. 230 V <sub>DC</sub> / 0.26 A / 60 W, 60 V <sub>DC</sub> / 1 A / 60 W, max. 240 V <sub>AC</sub> / 0.42 A / 100 W, 100 V <sub>AC</sub> / 1 A / 100 W



## Contacts with VKM-1..., VKM-3... use in hazardous areas

Mechanics:

The apparatus can be used as follows in explosive atmospheres in accordance with the applicable erection regulations on machines, devices and plants, such as e.g. EN 1127-1, EN 60079-14 etc.:



- a) In Zone 1 (gas hazard, category 2G) in the explosion groups IIA, IIB and IIC
- b) In Zone 2 (gas hazard, category 3G) in the explosion groups IIA, IIB and IIC
- c) In Zone 21 (dust hazard, category 2D) in the explosion groups IIIA and IIIB
- d) In Zone 22 (dust hazard, category 3D) in the explosion groups IIIA and IIIB

ATEX contact ...F0:

 II 2 G Ex mb IIC T6 Gb  
 II 2 D Ex mb IIC T80 °C Db  
max. 250 V<sub>AC</sub>/1.5 A/100 VA



ATEX N/O contact type 41T57

...G0 and GG:

 II 3 G Ex ic IIC T4 Gc  
 II 3 D Ex mb IIIC T125 °C Dc  
-20 °C ≤ Ta ≤ 80 °C  
max. 250 V<sub>AC/DC</sub>/1.5 A/100 W/100 VA

ATEX changeover contact type 41R57U

...H0 and HH:

 II 3 G Ex ic IIC T4 Gc  
 II 3 D Ex ic IIIC T125 °C Dc  
-20 °C ≤ Ta ≤ 80 °C  
max. 250 V<sub>AC/DC</sub>/1 A/30 W/60 VA

Hysteresis:

approx. 3.5 mm float movement

Protection:

IP 65 (electr. contact)  
IP 54 (side indicator)

## VKM-7..

Evaluating electronics:

Digital indication, bargraph indication or combined indication (digital/bargraph)

For technical information please see the operating instructions for ADI.

## VKM-8..

display:

3-digit LED display

indication:

semi conductor PNP or NPN

Analogue output:

4–20 mA, 3 wire version

max. 500 Ω, linear

Auxiliary power:

24 V<sub>DC</sub> +-20%

Max. temperature:

+80° C

Electrical conn.:

plug M12x1

## 12. Order Codes

Note: See KOBOLD USA Datasheet for USA Order Codes

### Viscosity-compensated flow switches model: VKM-1...

Measuring range L/min oil	Pressure loss $\Delta P$ (bar) at rated flow*		Brass	Stainless steel	Contact	Connection		Option special connection	Flow direction
	min.	max.							
0.01...0.07**	0.02	1.0	VKM-1101...	VKM-1201...	..R0.. = 1 N/O contact	..R08 = G 1/4 ..N08 = 1/4 NPT	..R15 = G 1/2 ..N15 = 1/2 NPT	0 = without option  B = outlet female thread inlet BVB manifold	B = from bottom T = from top L = from left R = from right
0.1...0.45	0.03	0.8	VKM-1102...	VKM-1202...	..U0.. = 1 changeover contact				
0.2...1.2	0.05	1.1	VKM-1103...	VKM-1203...	..F0.. = 1 EX N/O contact				
0.5...2	0.07	1.2	VKM-1104...	VKM-1204...	..CO.. = 1 N/O contact (cCSAus)				
0.8...3.4	0.05	0.9	VKM-1105...	VKM-1205...	..DO.. = 1 changeover contact (cCSAus)				
3...9	0.05	0.8	VKM-1106...	VKM-1206...	..GO.. = 1 ATEX N/O contact (model 41R57)				
4...14	0.08	1.1	VKM-1107...	VKM-1207...	..HO.. = 1 ATEX changeover contact (model 41R57U)				
5...20	0.05	1.1	VKM-1108...	VKM-1208...	..RR.. = 2 N/O contact				
4...40	0.1	0.4	VKM-1109...	VKM-1209...	..UU.. = 2 changeover contact				
5...55	0.15	1.1	VKM-1110...	VKM-1210...	..CC.. = 2 N/O contact (cCSAus)				
7...70	0.15	1.1	VKM-1111...	VKM-1211...	..DD.. = 2 changeover contact (cCSAus)				
8...80	0.15	1.1	VKM-1112...	VKM-1212...	..GG.. = 2 ATEX N/O contact (model 41R57) ..HH.. = 2 ATEX changeover contact (model 41R57U)	..R20 = G 3/4 ..R25 = G 1	..N20 = 3/4 NPT ..N25 = 1 NPT		

\* Pressure loss refers to water

\*\* Viscosity range 70...400 mm<sup>2</sup>/s

### Viscosity-compensated flow meters model: VKM-2...

Measuring range L/min oil	Pressure loss $\Delta P$ [bar] at rated flow*		Brass	Stainless steel	Contact	Connection		Option special connection	Flow direction
	min.	max.							
0.01...0.07**	0.02	1.0	VKM-2101...	VKM-2201...	00.. = without contact	..R08 = G 1/4	..N08 = 1/4 NPT	0 = without option  B = outlet female thread inlet BVB manifold	B = from bottom T = from top L = from left R = from right
0.1...0.45	0.03	0.8	VKM-2102...	VKM-2202...					
0.2...1.2	0.05	1.1	VKM-2103...	VKM-2203...					
0.5...2	0.07	1.2	VKM-2104...	VKM-2204...					
0.8...3.4	0.05	0.9	VKM-2105...	VKM-2205...					
3...9	0.05	0.8	VKM-2106...	VKM-2206...					
4...14	0.08	1.1	VKM-2107...	VKM-2207...					
5...20	0.05	1.1	VKM-2108...	VKM-2208...					
4...40	0.1	0.4	VKM-2109...	VKM-2209...					
5...55	0.15	1.1	VKM-2110...	VKM-2210...					
7...70	0.15	1.1	VKM-2111...	VKM-2211...	..R15 = G 1/2 ..R20 = G 3/4	..N15 = 1/2 NPT ..N20 = 3/4 NPT			
8...80	0.15	1.1	VKM-2112...	VKM-2212...	..R25 = G 1	..N25 = 1 NPT			

\* Pressure loss refers to water

\*\* Viscosity range 70...400 mm<sup>2</sup>/s

## Viscosity-compensated flow meters model: VKM-3...

Measuring range L/min oil	Pressure loss $\Delta P$ [bar] at rated flow*		Brass	Stainless steel	Contact	Connection		Option special connection	Flow direction
	min.	max.							
0.01...0.07**	0.02	1.0	VKM-3101...	VKM-3201...	..R0.. = 1 N/O contact	..R08 = G 1/4	..N08 = 1/4 NPT	0 = without option B = outlet female thread inlet BVB manifold	B = from bottom T = from top L = from left R = from right
0.1...0.45	0.03	0.8	VKM-3102...	VKM-3202...	..U0.. = 1 changeover contact				
0.2...1.2	0.05	1.1	VKM-3103...	VKM-3203...	..F0.. = 1 EX N/O contact				
0.5...2	0.07	1.2	VKM-3104...	VKM-3204...	..C0.. = 1 N/O contact (cCSAus)	..R08 = G 1/4	..N08 = 1/4 NPT		
0.8...3.4	0.05	0.9	VKM-3105...	VKM-3205...	..D0.. = 1 changeover contact (cCSAus)	..R15 = G 1/2	..N15 = 1/2 NPT		
3...9	0.05	0.8	VKM-3106...	VKM-3206...	..G0.. = 1 ATEX N/O contact (model 41R57)	..R15 = G 1/2	..N15 = 1/2 NPT		
4...14	0.08	1.1	VKM-3107...	VKM-3207...	..H0.. = 1 ATEX changeover contact (model 41R57U)	..R20 = G 3/4	..N20 = 3/4 NPT		
5...20	0.05	1.1	VKM-3108...	VKM-3208...	..RR.. = 2 N/O contact	..R20 = G 3/4	..N20 = 3/4 NPT		
4...40	0.1	0.4	VKM-3109...	VKM-3209...	..UU.. = 2 changeover contact	..R25 = G 1	..N25 = 1 NPT		
5...55	0.15	1.1	VKM-3110...	VKM-3210...	..CC.. = 2 N/O contact (cCSAus)				
7...70	0.15	1.1	VKM-3111...	VKM-3211...	..DD.. = 2 changeover contact (cCSAus)				
8...80	0.15	1.1	VKM-3112...	VKM-3212...	..GG.. = 2 ATEX N/O contact (model 41R57) ..HH.. = 2 ATEX changeover contact (model 41R57U)	..R25 = G 1	..N25 = 1 NPT		

\* Pressure loss refers to water

\*\* Viscosity range 70...400 mm<sup>2</sup>/s

## Viscosity-compensated flow meter with evaluating electronics model: VKM-7...

Measuring range L/min oil approx.	Pressure loss $\Delta P$ [bar] at rated flow*		Brass	Stainless steel	Output	Connection		Flow direction
	min.	max.				Standard	Sonder	
0.01-0.063**	0.02	1.0	VKM-7101...	VKM-7201...	...K04... = combination ind. 100-240 V <sub>AC/DC</sub> , ±10% (50-60 Hz)  ...K34... = combination ind. 10-40 V <sub>DC</sub> , 18-30 V <sub>AC</sub> 50/60 Hz	..R08 = G 1/4	..N08 = 1/4 NPT	B = from bottom T = from top L = from left R = from right
0.1...0.4	0.03	0.8	VKM-7102...	VKM-7202...		..R08 = G 1/4	..N08 = 1/4 NPT	
0.2...1.1	0.05	1.1	VKM-7103...	VKM-7203...		..R15 = G 1/2	..N15 = 1/2 NPT	
0.5...1.8	0.07	1.2	VKM-7104...	VKM-7204...		..R15 = G 1/2	..N15 = 1/2 NPT	
0.8...3.1	0.05	0.9	VKM-7105...	VKM-7205...		..R20 = G 3/4	..N20 = 3/4 NPT	
3...8.1	0.05	0.8	VKM-7106...	VKM-7206...		..R20 = G 3/4	..N20 = 3/4 NPT	
4...12.6	0.08	1.1	VKM-7107...	VKM-7207...		..R25 = G 1	..N25 = 1 NPT	
5...18	0.05	1.1	VKM-7108...	VKM-7208...		..R25 = G 1	..N25 = 1 NPT	
4...36	0.1	0.4	VKM-7109...	VKM-7209...				
5...50	0.15	1.1	VKM-7110...	VKM-7210...				
7...63	0.15	1.1	VKM-7111...	VKM-7211...				
8...72	0.15	1.1	VKM-7112...	VKM-7212...				

\* Pressure loss refers to water

\*\* Viscosity range 70...400 mm<sup>2</sup>/s

## Viscosity-compensated flow meter with compact electronics model: VKM-8...

Measuring range L/min oil approx.	Pressure loss $\Delta P$ [bar] at rated flow*		Brass	Stainless steel	Output	Connection		Flow direction
	min.	max.						
0.01-0.063**	0.02	1.0	VKM-8101...	VKM-8201...	...C0R... = compact electr. 24 V <sub>DC</sub> , 2x PNP ...C0M... = compact electr. 24 V <sub>DC</sub> , 2xNPN ...C4P... = compact electr. 24 V <sub>DC</sub> , 4-20 mA, 1xPNP ...C4N... = compact electr. 24 V <sub>DC</sub> , 4-20 mA, 1xNPN	..R08 = G 1/4	..N08 = 1/4 NPT	B = from bottom T = from top L = from left R = from right
0.1...0.4	0.03	0.8	VKM-8102...	VKM-8202...		..R08 = G 1/4	..N08 = 1/4 NPT	
0.2...1.1	0.05	1.1	VKM-8103...	VKM-8203...		..R15 = G 1/2	..N15 = 1/2 NPT	
0.5...1.8	0.07	1.2	VKM-8104...	VKM-8204...		..R15 = G 1/2	..N15 = 1/2 NPT	
0.8...3.1	0.05	0.9	VKM-8105...	VKM-8205...		..R20 = G 3/4	..N20 = 3/4 NPT	
3...8.1	0.05	0.8	VKM-8106...	VKM-8206...		..R20 = G 3/4	..N20 = 3/4 NPT	
4...12.6	0.08	1.1	VKM-8107...	VKM-8207...		..R25 = G 1	..N25 = 1 NPT	
5...18	0.05	1.1	VKM-8108...	VKM-8208...		..R25 = G 1	..N25 = 1 NPT	
4...36	0.1	0.4	VKM-8109...	VKM-8209...				
5...50	0.15	1.1	VKM-8110...	VKM-8210...				
7...63	0.15	1.1	VKM-8111...	VKM-8211...				
8...72	0.15	1.1	VKM-8112...	VKM-8212...				

\* Pressure loss refers to water

\*\* Viscosity range 70...400 mm<sup>2</sup>/s



## 13. Recommended Spare-Parts

Only the instrument parts and material are listed. Depending on the instrument type the parts are available in various sizes (when ordering please indicate instrument type).

- |                                     |                                    |
|-------------------------------------|------------------------------------|
| 1.1) Float Brass                    | 5.1) N/O contact (standard)        |
| 1.2) Float Stainless Steel          | 5.2) Changeover contact (standard) |
| 2.1) Slotted-nozzle Brass           | 5.3) N/O contact Ex                |
| 2.2) Slotted-nozzle Stainless Steel | 5.4) N/O contact (cCSAus)          |
| 3.1) Spring St. Steel               | 5.5) Changeover contact (cCSAus)   |
| 4.1) O-Ring set NBR                 |                                    |
| 4.2) O-Ring set FPM                 |                                    |

## 14. Dimensions

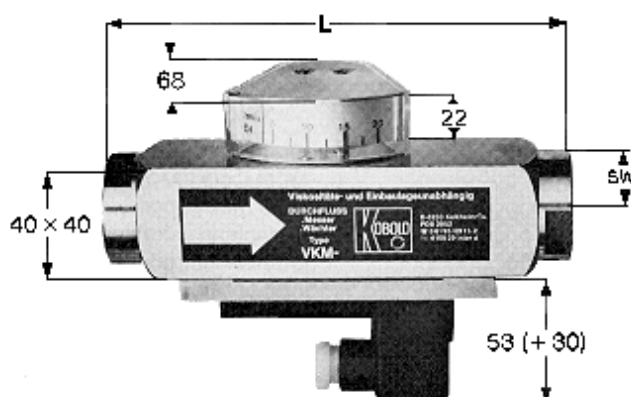

Model	Square (mm)	Length (mm) Connection	SW (mm) Connection	Weight* (kg)
VKM-..01	40x40	162	36	1,7
VKM-..02	40x40	162	36	1,7
VKM-..03	40x40	162	36	1,7
VKM-..04	40x40	162	36	1,7
VKM-..05	40x40	162	36	1,7
VKM-..07	40x40	162	36	1,6
VKM-..08	40x40	162	36	1,6
VKM-..09	40x40	162 (186,5)**	36 (41)**	1,7
VKM-..10	40x40	162 (186,5)**	36 (41)**	1,7
VKM-..11	40x40	162 (186,5)**	36 (41)**	1,7
VKM-..12	40x40	186,5	41	1,7

\* Weight valid for: VKM-1..., VKM-2...  
for model VKM-3... + 0,1 kg  
for model VKM-7... + 1,4 kg

\*\* at G1 or 1 NPT

## VKM-1..., VKM-2..., VKM-3..

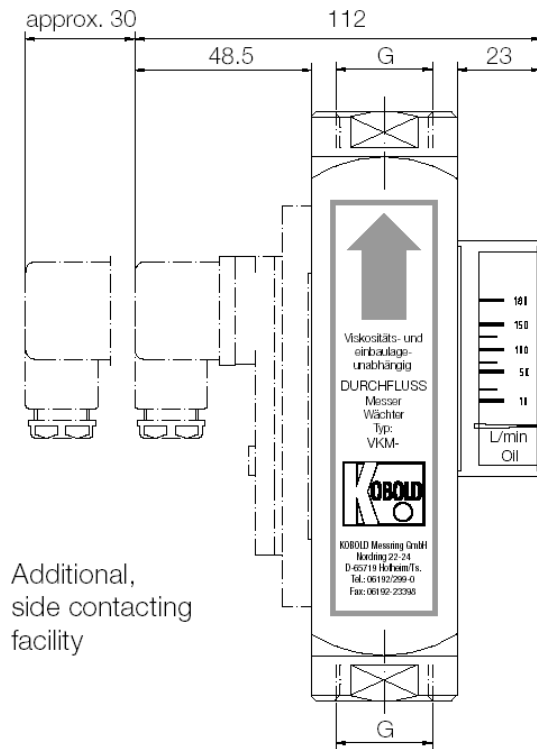

## VKM-7...

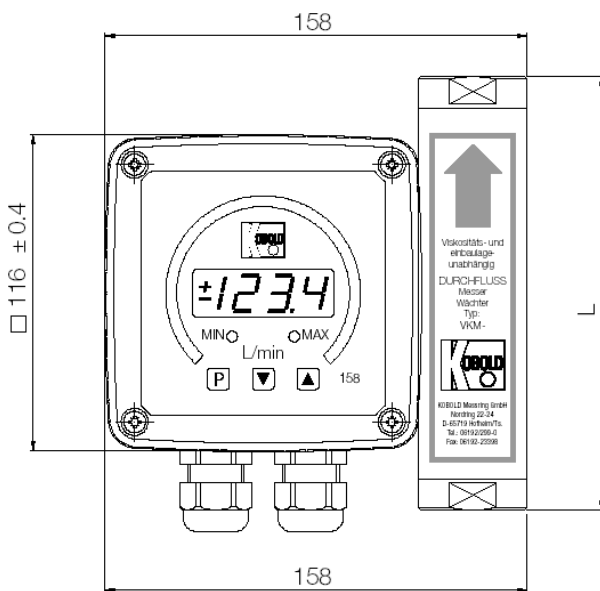

Depth 127 mm

## VKM-8...

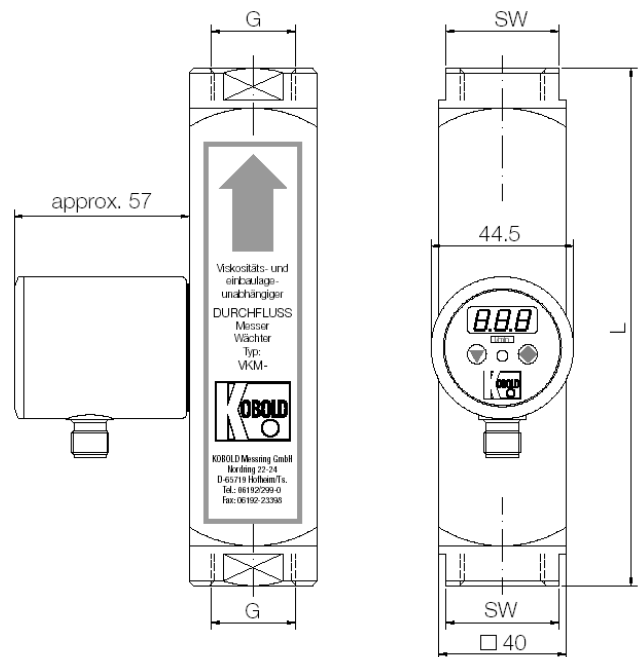

## Ex contact for VKM-..F0..

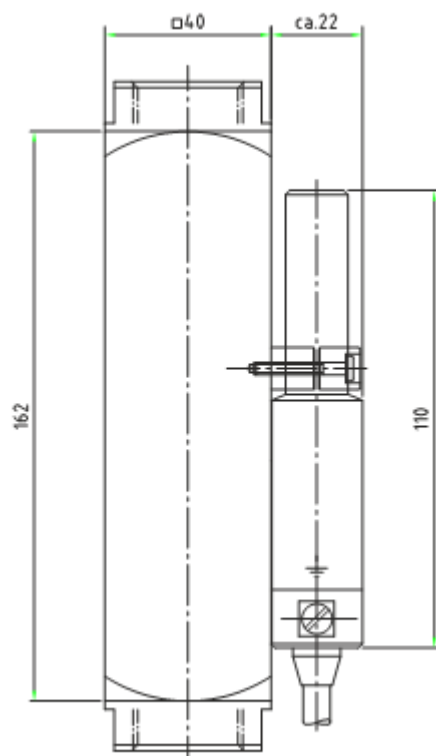

## 15. EU Declaration of Conformance (VKM)

---

We, KOBOLD Messring GmbH, Hofheim-Ts, Germany, declare under our sole responsibility that the product:

**Flow Meter and Monitor                      Model VKM**

to which this declaration relates is in conformity with the standards noted below:

**EN 61010-1:2011-07**

Safety requirements for electrical equipment for measuring control and laboratory use

**EN 60529:2014-09**

Protection type through case (IP code)

**EN 60079-0:2009**

General Regulations

**EN 60079-18:2009**

Encapsulation „m“

**EN 50581:2012**

Technical documentation for the assessment of electrical and electronic products with respect to the restriction of hazardous substances

Also the following EC guidelines are fulfilled:

**2014/35/EU**    Low Voltage Directive

**2014/34/EU**    Equipment and Protective systems intended for use in a potentially Explosive Atmospheres (ATEX 100a)

**Quality Management Production**

Certificate number: BVS 18 ATEX ZQS/E110

Notified body: DEKRA Exam GmbH

Identification number: 0158

**2011/65/EU**    **RoHS** (category 9)



H. Peters  
General Manager



M. Wenzel  
Proxy Holder

Hofheim, 11. Jan. 2018

## 16. EU declaration of conformance (reed contact 41R57\*\*)

EU-KONFORMITÄTSERKLÄRUNG zur Bestätigung der Übereinstimmung einer Baugruppe mit der Richtlinie 2014/34/EU

EU DECLARATION OF CONFORMITY to confirm the conformance of a device with the Directive 2014/34/EU

Der Hersteller

The manufacturer

**KOBOLD Messring GmbH, Nordring 22-24, DE 65719 Hofheim**

erklärt hiermit in alleiniger Verantwortung, dass die nachfolgende Maschine oder Baugruppe

hereby declares under sole responsibility, that the machinery or subassembly equipment described below

Bezeichnung

Description

**Reed-Schalter / Reed contact 41R57\*\***

Kennzeichnung / Marking:  II 3G Ex ic IIC T4 Gc or  II 3D Ex ic IIIC T125 °C Dc

Fertigungs-Nummer lt. Lieferpapieren und Typenschild

Serial number see shipping documents and type label

mit den Bestimmungen folgender harmonisierter Normen der Europäischen Union:

conforms with the provisions of the following harmonized standards in the version of the European Union:

- IEC 60079-0:2017 Explosionsgefährdete Bereiche – Teil 0: Betriebsmittel - Allgemeine Anforderungen
- EN 60079-11:2012 Explosionsgefährdete Bereiche – Teil 11: Geräteschutz durch Eigensicherheit "i"

- IEC 60079-0:2017 Explosive atmospheres – Part 0: General Requirements
- EN 60079-11:2012 Explosive atmospheres – Part 11: Equipment protection by intrinsic safety "i"

Ebenfalls mit folgenden Europäischen und nationalen Normen und technischen Vorschriften, in der zum Unterschriftsdatum gültigen Fassung, übereinstimmt:

Also conforms with the following European and National Standards and technical provisions in the version, valid at signature date:

- Technische Regeln für Gefahrstoffe (TRGS) 727:2016, Vermeidung von Zündgefahren infolge elektrostatischer Aufladungen

- Technical rules for hazardous substances TRGS 727:2016, Avoidance of ignition hazards as consequence of electrostatic charging

Ausgefertigt in Hofheim am 21. März 2019

done at Hofheim on March, 21 2019



Name des Unterzeichners

Name of signatory

Manfred Wenzel

Prokrist / authorized signatory

Unterzeichnet für und im Namen der / Signed for and on behalf of KOBOLD Messring GmbH

Unterschrift / signatur

# 17. Declaration of the Manufacturer (Ex RC...)



**.steute**

## EU-KONFORMITÄTSERKLÄRUNG EU DECLARATION OF CONFORMITY

gemäß der Explosionsschutz-Richtlinie 2014/34/EU  
according to Explosion Protection Directive 2014/34/EU

Als Hersteller trägt die Firma steute Technologies die alleinige Verantwortung für die Ausstellung dieser Konformitätserklärung /  
As manufacturer, steute Technologies is solely responsible for issuing this Declaration of Conformity.

**Art und Bezeichnung der Betriebsmittel /  
Type and name of equipment:** Ex Magnetsensor, Typen Ex RC ...  
Ex magnetic sensor, types Ex RC ...

Hiermit erklären wir, dass die oben aufgeführten elektrischen Betriebsmittel aufgrund der Konzipierung und Bauart den grundlegenden Sicherheits- und Gesundheitsanforderungen nach Anhang II der Richtlinie 2014/34/EU entsprechen. /  
We hereby declare that, due to its design and construction, the above mentioned electrical equipment satisfies the requirements of directive 2014/34/EU in respect to basic safety and health requirements according to Annex II.

Angewandte EU-Richtlinie / Applied EU directive	Harmonisierte Normen / Harmonised standards	Neueste harmonisierte Normen / Latest harmonised standards
2014/34/EU Explosionsschutzrichtlinie / 2014/34/EU Explosion Protection Directive	EN 60079-0:2012 +A11:2013, EN 60079-18:2015	
EG-Baumusterprüfung / EU-type examination:	Ex-Kennzeichnung / Ex marking	Neueste Ex-Kennzeichnung / Latest Ex marking
DMT 01 ATEX E 058 X	Ⓜ II 2G Ex mb IIC T4 Gb Ⓜ II 2D Ex mb IIIC T80°C Db	
Weitere angewandte EU-Richtlinien / Additionally applied EU directives	Harmonisierte Normen / Harmonised standards	Anmerkungen / Comments
2014/35/EU Niederspannungsrichtlinie / 2014/35/EU Low Voltage Directive	EN 60947-5-2:2007 +A1:2012	-
2014/30/EU EMV-Richtlinie / 2014/30/EU EMC Directive	nicht anwendbar nach EN 60947-1:2007 +A1:2011 +A2:2014 not applicable to EN 60947-1:2007 +A1:2011 +A2:2014	-
2011/65/EU RoHS-Richtlinie / 2011/65/EU RoHS Directive	EN 50581:2012	-

**Benannte Stelle der EG-Baumusterprüfung /  
Notified body for EU-type examination:** Dekra Exam GmbH  
Dinnendahlstr. 9  
44809 Bochum  
Kenn-Nr. 0158

**Überwachende Stelle nach Anhang IV/VII der  
Richtlinie 2014/34/EU /  
Notified body according to Annex IV/VII of  
Directive 2014/34/EU:** Dekra Exam GmbH  
Dinnendahlstr. 9  
44809 Bochum  
Kenn-Nr. 0158

**Verantwortlich technische Dokumentation /  
Responsible for technical documentation:** Marc Stanesby (Geschäftsführer)  
Marc Stanesby (Managing Director)

Löhne, 07. Dezember 2018 / December 7th, 2018  
Ort und Datum der Ausstellung / Place and date of issue

Rechtsverbindliche Unterschrift,  
Marc Stanesby (Geschäftsführer) /  
Legally binding signature,  
Marc Stanesby (Managing Director)

steute Technologies GmbH & Co KG, Brückenstr. 91, 32584 Löhne, Germany

# 18. EC-Type Examination Certificate Magnetic reed switch Ex RC



Translation

## 1 EU-Type Examination Certificate Supplement 6

Change to Directive 2014/34/EU

2 Equipment intended for use in potentially explosive atmospheres  
Directive 2014/34/EU

3 EU-Type Examination Certificate Number: **DMT 01 ATEX E 058 X**

4 Product: **Magnetic switch type Ex RC\*\*\*\*\***

5 Manufacturer: **Steute Schaltgeräte GmbH & Co. KG**

6 Address: **Brückenstraße 91, 32584 Löhne, Germany**

7 This supplementary certificate extends EC-Type Examination Certificate No. DMT 01 ATEX E 058 X to apply to products designed and constructed in accordance with the specification set out in the appendix of the said certificate but having any acceptable variations specified in the appendix to this certificate and the documents referred to therein.

8 DEKRA EXAM GmbH, Notified Body number 0158, in accordance with Article 17 of Directive 2014/34/EU of the European Parliament and of the Council, dated 26 February 2014, certifies that this product has been found to comply with the Essential Health and Safety Requirements relating to the design and construction of products intended for use in potentially explosive atmospheres given in Annex II to the Directive.  
The examination and test results are recorded in the confidential Report No. PP 01.2051 EU.

9 Compliance with the Essential Health and Safety Requirements has been assured by compliance with:

**EN 60079-0:2012 + A11:2013** General requirements  
**EN 60079-18:2015** Encapsulation "m"

10 If the sign "X" is placed after the certificate number, it indicates that the product is subject to the Special Conditions for Use specified in the appendix to this certificate.

11 This EU-Type Examination Certificate relates only to the design and construction of the specified product. Further requirements of the Directive apply to the manufacturing process and supply of this product. These are not covered by this certificate.

12 The marking of the product shall include the following:

 **II 2G Ex mb IIC T8 Gb**  
**II 2D Ex mb IIIC T80°C Db**

DEKRA EXAM GmbH  
Bochum, 2016-09-23

Signed: Dr. Franz Eickhoff

Certifier

Signed: Ralf Leiendecker

Approver



Page 1 of 3 of DMT 01 ATEX E 058 X / N6  
This certificate may only be reproduced in its entirety and without any change.

DEKRA EXAM GmbH, Dinnendahlstraße 9, 44809 Bochum, Germany,  
telephone +49.234.3696-105, Fax +49.234.3696-110, zs-exam@dekra.com



13 **Appendix**  
 14 **EU-Type Examination Certificate**

**DMT 01 ATEX E 058 X  
 Supplement 6**

15 **Product description**

15.1 **Subject and type**

Magnetic switch type Ex RC\*\*\*\*\*

- 1. Asterisk      Housing design:
  - 12            Diameter 12 mm
  - 13.5        Diameter 13.5 mm
  - M14        Mounting thread M14 x 1
  - 15           Diameter 15 mm
  - M20        Mounting thread M20 x 1.5
  - 2580        Housing dimensions 25 mm x 80 mm
- 2. Asterisk      Contact function:
  - W           Change-over contact
  - Wr          Change-over contact latching
  - S            Normally open contact
  - Sr          Normally open contact latching
  - Ö            Normally closed contact
- 3. Asterisk      Cable length
- 4. Asterisk      Housing material
  - Blank      Brass
  - KST        Thermoplastic
  - Niro        Stainless steel
- 5. Asterisk      Lower ambient temperature range
  - Blank      -20 °C
  - 40 °C     -40 °C
  - 60 °C     -60 °C
- 6. Asterisk      Allowed impact
  - Blank      7 Joule
  - 4J          4 Joule

15.2 **Description**

With this supplement the certificate is changed to Directive 2014/34/EU. (Annotation: In accordance with Article 41 of Directive 2014/34/EU, EC-Type Examination Certificates referring to 94/9/EC that were in existence prior to the date of application of 2014/34/EU (20 April 2016) may be referenced as if they were issued in accordance with Directive 2014/34/EU. Supplementary Certificates to such EC-Type Examination Certificates, and new issues of such certificates, may continue to bear the original certificate number issued prior to 20 April 2016.)

The magnetic switch is designed in type of protection Encapsulation "m" and will be used for the implementation of switching operations.

**Reason for this supplement:**

- Change to Directive 2014/34/EU.
- Updating of the applicable standards.
- New magnetic switch type Ex RC M20\*\*KST -60 °C\*

Page 2 of 3 of DMT 01 ATEX E 058 X / N6  
 This certificate may only be reproduced in its entirety and without any change.



DEKRA EXAM GmbH, Dinnendahlstrasse 9, 44809 Bochum, Germany.  
 telephone +49.234.3696-105, Fax +49.234.3696-110, zs-exam@dekra.com



**15.3 Parameters****15.3.1 Electrical Data**

Switching voltage	up to	AC 250	V
Switching current	up to	1.5	A
Switching power for change-over contact and for normally closed contact	up to	50	VA/W
Switching power for normally open contact	up to	100	VA/W
Short-circuit current $I_k$ for change-over contact and for normally closed contact	up to	2	A
Short-circuit current $I_k$ for normally open contact	up to	5	A

**15.3.2 Thermal Data**

Ambient temperature range (Marking on the nameplate)	-20 °C up to +40 °C
or	-20 °C up to +70 °C
or	-40 °C up to +70 °C
or	-60 °C up to +70 °C

**16 Report Number**

BVS PP 01.2051 EU, as of 2016-09-23

**17 Special Conditions for Use**

- 17.1 The ends of the permanent cables have to be connected inside enclosures that have been certified for the use in the relevant category accordingly.
- 17.2 The short circuit current  $I_k$  of the supply source may not exceed the mentioned parameters in 15.3.1, ensured by an external protective device.
- 17.3 The magnetic switch type Ex RC 12\*\*\*\*\* must be assembled in a way that is protected from mechanical hazards.
- 17.4 The magnetic switch type Ex RC\*\*\*\*\*4J must be assembled in a way that is protected from mechanical hazards.

**18 Essential Health and Safety Requirements**

The Essential Health and Safety Requirements are covered by the standards listed under item 9.

**19 Drawings and Documents**

Drawings and documents are listed in the confidential report.

We confirm the correctness of the translation from the German original.  
In the case of arbitration only the German wording shall be valid and binding.

DEKRA EXAM GmbH  
Bochum, dated 2016-09-23  
BVS-Pe/Mu A 20150400

  
Certifier

  
Approver



Page 3 of 3 of DMT 01 ATEX E 058 X / N6  
This certificate may only be reproduced in its entirety and without any change.

DEKRA EXAM GmbH, Dinnendahlstrasse 9, 44809 Bochum, Germany,  
telephone +49.234.3696-105, Fax +49.234.3696-110, zs-exam@dekra.com

# 19. IECEx certificate (Ex RC)

		<h2>IECEx Certificate of Conformity</h2>	
<p><b>INTERNATIONAL ELECTROTECHNICAL COMMISSION</b>  <b>IEC Certification Scheme for Explosive Atmospheres</b>  <small>for rules and details of the IECEx Scheme visit <a href="http://www.iecex.com">www.iecex.com</a></small></p>			
Certificate No.:	IECEx BVS 07.0007X	Issue No: 3	Certificate history:
Status:	Current	Page 1 of 5	Issue No. 3 (2019-02-27) Issue No. 2 (2016-10-07) Issue No. 1 (2014-05-12) Issue No. 0 (2007-04-12)
Date of Issue:	2019-02-27		
Applicant:	<b>Steute Technologies GmbH &amp; Co. KG</b> Brückenstraße 91 32584 Löhne Germany		
Equipment:	<b>Magnetic switch type Ex RC*****</b> <i>Optional accessory:</i>		
Type of Protection:	<b>Equipment protection by encapsulation "m"</b>		
Marking:	Ex mb IIC T6 Gb Ex mb IIIC T80°C Db		
Approved for issue on behalf of the IECEx Certification Body:	Jörg Koch		
Position:	Head of Certification Body		
Signature: (for printed version)			
Date:	27.2.19		
1. This certificate and schedule may only be reproduced in full. 2. This certificate is not transferable and remains the property of the issuing body. 3. The Status and authenticity of this certificate may be verified by visiting the <a href="http://www.iecex.com">Official IECEx Website</a> .			
Certificate issued by:			
DEKRA Testing and Certification GmbH Certification Body Dinnendahlstrasse 9 44809 Bochum Germany		 <b>DEKRA</b> On the safe side.	



## IECEX Certificate of Conformity

Certificate No: IECEx BVS 07.0007X Issue No: 3  
Date of Issue: 2019-02-27 Page 2 of 5  
Manufacturer: **Steute Technologies GmbH & Co. KG**  
Brückenstraße 91  
32584 Löhne  
Germany

Additional Manufacturing location(s):

This certificate is issued as verification that a sample(s), representative of production, was assessed and tested and found to comply with the IEC Standard list below and that the manufacturer's quality system, relating to the Ex products covered by this certificate, was assessed and found to comply with the IECEx Quality system requirements. This certificate is granted subject to the conditions as set out in IECEx Scheme Rules, IECEx 02 and Operational Documents as amended.

#### STANDARDS:

The apparatus and any acceptable variations to it specified in the schedule of this certificate and the identified documents, was found to comply with the following standards:

IEC 60079-0 : 2011 Explosive atmospheres - Part 0: General requirements  
Edition:6.0  
IEC 60079-18 : 2014 Explosive atmospheres – Part 18: Equipment protection by encapsulation "m"  
Edition:4.0

*This Certificate does not indicate compliance with electrical safety and performance requirements other than those expressly included in the Standards listed above.*

#### TEST & ASSESSMENT REPORTS:

*A sample(s) of the equipment listed has successfully met the examination and test requirements as recorded in*

Test Report:

[DE/BVS/ExTR07.0008/02](#)

Quality Assessment Report:

[DE/BVS/QAR06.0023/11](#)

	<b>IECEX Certificate of Conformity</b>	
Certificate No:	IECEX BVS 07.0007X	Issue No: 3
Date of Issue:	2019-02-27	Page 3 of 5
<b>Schedule</b>		
<b>EQUIPMENT:</b> <i>Equipment and systems covered by this certificate are as follows:</i>		
<b>Description</b> The magnetic switch is designed in type of protection Encapsulation "m" and will be used for the implementation of switching operations.		
<b>Subject and Type</b> See Annex		
<b>SPECIFIC CONDITIONS OF USE: YES as shown below:</b>		
<ul style="list-style-type: none"><li>- The ends of the permanent cables have to be connected inside enclosures that have been certified for the use in the relevant category accordingly.</li><li>- The short circuit current I<sub>k</sub> of the supply source may not exceed the mentioned parameters, ensured by an external protective device.</li><li>- The magnetic switch type Ex RC 12***** must be assembled in a way that is protected from mechanical hazards.</li><li>- The magnetic switch type Ex RC*****4 J must be assembled in a way that is protected from mechanical hazards.</li></ul>		



## IECEx Certificate of Conformity

Certificate No: IECEx BVS 07.0007X

Issue No: 3

Date of Issue: 2019-02-27

Page 4 of 5

### EQUIPMENT (continued):

#### Parameters

##### Electrical Data

Switching voltage	up to	AC	250	V
Switching current	up to		1.5	A
Switching power for change-over contact and for normally closed contact	up to		50	VA/W
Switching power for normally open contact	up to		100	VA/W
Short-circuit current $I_k$ for change-over contact and for normally closed contact	up to		2	A
Short-circuit current $I_k$ for normally open contact	up to		5	A

##### Thermal Data

Ambient temperature range (Marking on the nameplate)	-20 °C up to +40 °C
or	-20 °C up to +70 °C
or	-40 °C up to +70 °C
or	-60 °C up to +70 °C



## IECEx Certificate of Conformity

---

Certificate No: IECEx BVS 07.0007X

Issue No: 3

Date of Issue: 2019-02-27

Page 5 of 5

**DETAILS OF CERTIFICATE CHANGES (for issues 1 and above):**

The name of the company was updated and the latest issue of the QAR was inserted.  
No further changes were made.

**Annex:**

[BVS\\_07\\_0007X\\_Steute\\_Annex\\_issue3.pdf](#)



## IECEX Certificate of Conformity



**Certificate No.:** IECEx BVS 07.0007X issue No.: 3  
**Annex**  
 Page 1 of 1

**Subject and Type**

Magnetic switch type Ex RC\*\*\*\*\*

- |             |  |
|-------------|--|
| 1. Asterisk | Housing design:<br>12            Diameter 12 mm<br>13.5        Diameter 13.5 mm<br>M14         Mounting thread M14 x 1<br>15           Diameter 15 mm<br>M20         Mounting thread M20 x 1.5<br>2580        Housing dimensions 25 mm x 80 mm |
| 2. Asterisk | Contact function:<br>W            Change-over contact<br>Wr          Change-over contact latching<br>S            Normally open contact<br>Sr          Normally open contact latching<br>Ö            Normally closed contact                  |
| 3. Asterisk | Cable length   |
| 4. Asterisk | Housing material<br>Blank        Brass<br>KST         Thermoplastic<br>Niro         Stainless steel  |
| 5. Asterisk | Lower ambient temperature range<br>Blank        -20 °C<br>-40 °C      -40 °C<br>-60 °C      -60 °C   |
| 6. Asterisk | Allowed impact<br>Blank        7 Joule<br>4 J            4 Joule   |