

# Turbine Flow Meter

## B16D Series FloClean Sanitary



## CONTENTS

Scope of This Manual . . . . .	3
Unpacking and Inspection . . . . .	3
Safety . . . . .	3
Terminology and Symbols . . . . .	3
Considerations . . . . .	3
Introduction. . . . .	4
Operating Principle . . . . .	4
Installation. . . . .	5
Plumbing. . . . .	5
Wiring. . . . .	7
Operational Startup. . . . .	9
Meter Repair And Cleaning . . . . .	9
Repair Kits . . . . .	9
Turbine Repair Kits Part Numbers . . . . .	9
Service Procedures. . . . .	10
B16D Series (Cop/Sop) 3-A Turbine Installation . . . . .	11
Troubleshooting Guide. . . . .	12
3-A Certificate . . . . .	13
Specifications. . . . .	14
Part Number Information . . . . .	14
Dimensions and Drawing . . . . .	15
Part Numbering Construction . . . . .	16

## SCOPE OF THIS MANUAL

This manual is intended to help you get the FloClean Sanitary Meter up and running quickly.

### IMPORTANT

*Read this manual carefully before attempting any installation or operation. Keep the manual accessible for future reference.*

## UNPACKING AND INSPECTION

Upon opening the shipping container, visually inspect the product and applicable accessories for any physical damage such as scratches, loose or broken parts, or any other sign of damage that may have occurred during shipment.

**NOTE:** If damage is found, request an inspection by the carrier's agent within 48 hours of delivery and file a claim with the carrier. A claim for equipment damage in transit is the sole responsibility of the purchaser.

## SAFETY

### Terminology and Symbols



Indicates a hazardous situation, which, if not avoided, is estimated to be capable of causing death or serious personal injury.



Indicates a hazardous situation, which, if not avoided, could result in severe personal injury or death.



Indicates a hazardous situation, which, if not avoided, is estimated to be capable of causing minor or moderate personal injury or damage to property.

### Considerations

The installation of the FloClean Sanitary Meter must comply with all applicable federal, state, and local rules, regulations, and codes.



**EXPLOSION HAZARD - SUBSTITUTION OF COMPONENTS MAY IMPAIR SUITABILITY FOR CLASS I, DIVISION 2.**



**RISQUE D'EXPLOSION - LA SUBSTITUTION DE COMPOSANTS PEUT RENDRE CEMATÉRIEL INACCEPTABLE POUR LES EMPLACEMENTS DE CLASSE I, DIVISION 2.**



**DO NOT CONNECT OR DISCONNECT EITHER POWER OR OUTPUTS UNLESS THE AREA IS KNOWN TO BE NON-HAZARDOUS.**



**RISQUE D'EXPLOSION. NE PAS DÉBRANCHER TANT QUE LE CIRCUIT EST SOUSTENSION, À MOINS QU'LL NE S'AGISSE D'UN EMPLACEMENT NON DANGEREUX.**

### IMPORTANT

*Not following instructions properly may impair safety of equipment and/or personnel.*

## INTRODUCTION

The Blancett FloClean turbine flow meter is designed with wear-resistant moving parts for trouble-free operation and long service life. The durable 316L stainless steel construction is a cost efficient flow measurement system that offers excellent accuracy and repeatability. The FloClean turbine meter repair kit is designed for easy field service of a damaged flow meter, rather than replacing the entire flow meter. See “Repair Kits” on page 9 for information.

## OPERATING PRINCIPLE

Fluid entering the meter passes through the inlet flow straightener, which reduces its turbulent flow pattern and improves the fluid’s velocity profile. Fluid then passes through the turbine, causing it to rotate at a speed proportional to the fluid velocity. As each turbine blade passes through the magnetic field, the blade generates an AC voltage pulse in the pickup coil at the base of the magnetic pickup. These pulses produce an output frequency proportional to the volumetric flow through the meter. The output frequency represents flow rate and/or totalization of fluid passing through the turbine flow meter.

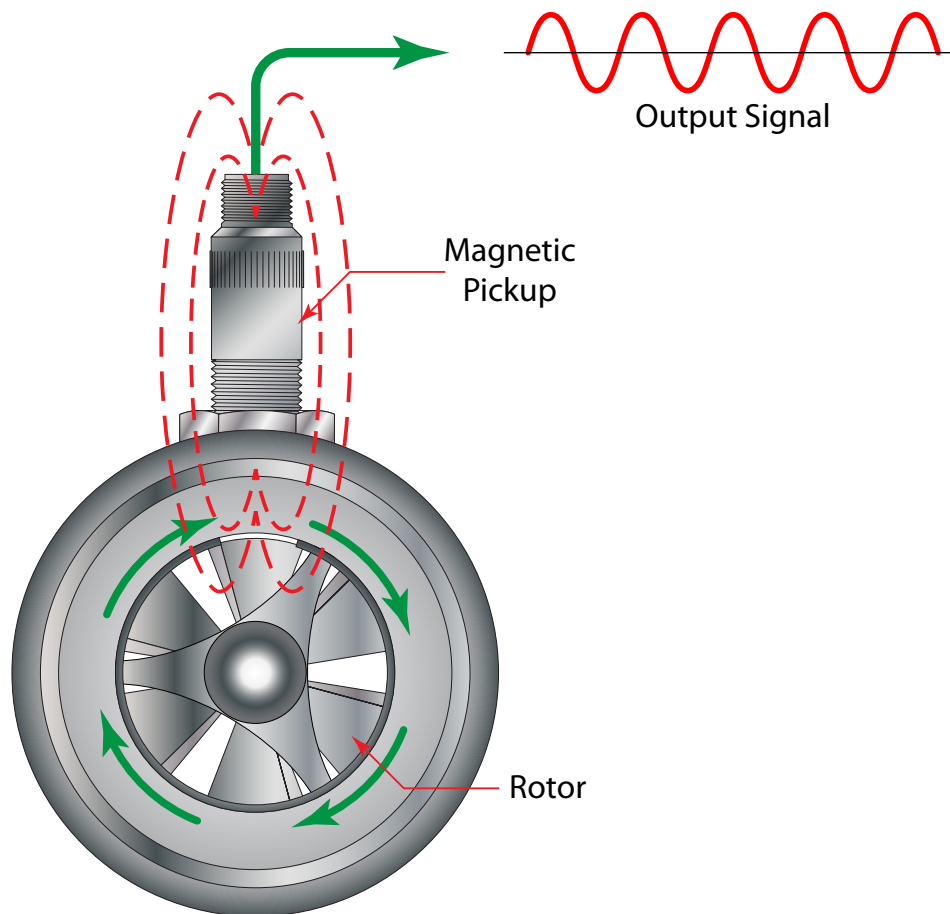

Figure 1: Operating principle

## INSTALLATION

### **CAUTION**

**THE METER SHOULD NOT BE SUBJECTED TO TEMPERATURES ABOVE 300° F (149° C), BELOW -150° F (-101° C) OR THE FREEZING POINT OF THE METERED LIQUID. HIGH TEMPERATURES WILL DAMAGE THE MAGNETIC PICKUP, WHILE LOWER TEMPERATURES WILL LIMIT THE ROTATION OF THE ROTOR.**

### **CAUTION**

**INCOMPATIBLE FLUIDS COULD DETERIORATE INTERNAL PARTS AND CAUSE THE METER TO READ INACCURATELY.**

### Plumbing

Install the flow meter with the flow arrow, which is etched on the exterior of the meter body, pointing in the direction of fluid flow. Install the meter horizontally with the magnetic pickup facing upward.

The liquid being measured must be free of any large particles that may obstruct spinning of the rotor. If particles are present, install a mesh strainer.

If small particles are present in the fluid, install a strainer upstream of the meter. See *Table 1* for filtration recommendations.

Bore Size	Ferrule Size	Strainer Size	Clearance
3/8 in. (9.53 mm)	0.984 in. (24.99 mm)	60 × 60	0.0092 in. (0.23 mm)
1/2 in. (12.7 mm)	0.984 in. (24.99 mm)	60 × 60	0.0092 in. (0.23 mm)
3/4 in. (19.05 mm)	0.984 in. (24.99 mm)	60 × 60	0.0092 in. (0.23 mm)
1/2 in. (12.7 mm)	1.984 in. (50.39 mm)	60 × 60	0.0092 in. (0.23 mm)
3/4 in. (19.05 mm)	1.984 in. (50.39 mm)	60 × 60	0.0092 in. (0.23 mm)
7/8 in. (22.23 mm)	1.984 in. (50.39 mm)	60 × 60	0.0092 in. (0.23 mm)
1 in. (25.4 mm)	1.984 in. (50.39 mm)	60 × 60	0.0092 in. (0.23 mm)
1-1/2 in. (38.1 mm)	1.984 in. (50.39 mm)	20 × 20	0.034 in. (0.86 mm)
2 in. (50.8 mm)	3.047 in. (77.39 mm)	10 × 10	0.065 in. (1.651 mm)

*Table 1: Straighter size recommendations*

Severe pulsation and mechanical vibration affects accuracy and shortens the life of the meter.

Install a bypass line to accommodate inspection and repair without interrupting flow. See *Figure 2*. If a bypass line cannot be used, install all control valves or restrictions that may cause the liquid to flash downstream of the flow meter. Install air eliminators to make sure that the meter is not incorrectly measuring entrained air or gas. See *Figure 3 on page 6*.

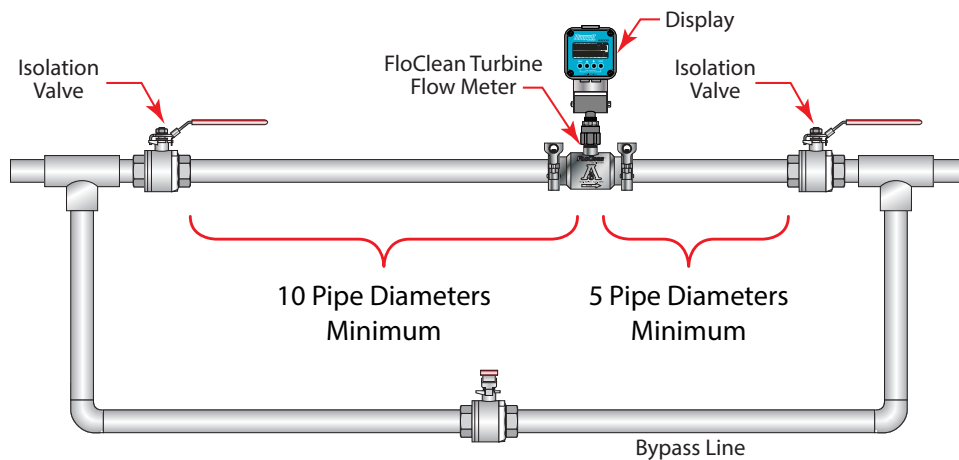

Figure 2: Installation with bypass line

Install a minimum length of 10 pipe diameters of straight pipe on the upstream side, and 5 diameters on the downstream side of the flow meter. The piping should be the same size as the meter bore or threaded port size.

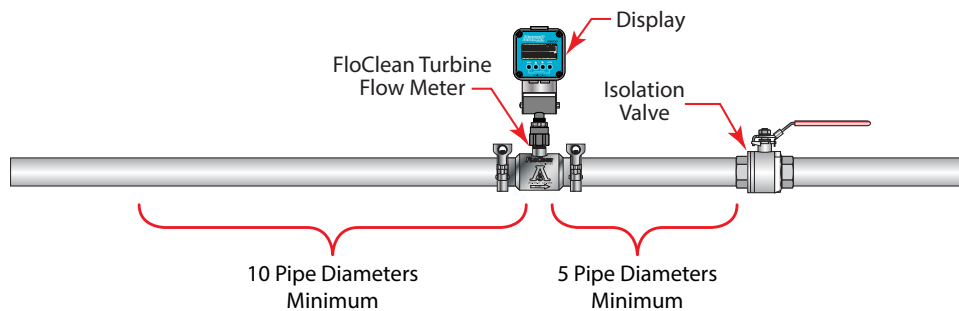

Figure 3: Installation without a bypass line

Do not install the flow meter or connection cable close to electric motors, transformers, sparking devices or high voltage lines. Do not place connecting cable in the same conduit with wires that furnish power for such devices. These devices can induce false signals in the flow meter coil or cable causing the meter to read inaccurately.

**CAUTION**

**DAMAGE CAN BE CAUSED BY STRIKING AN EMPTY METER WITH A HIGH VELOCITY FLOW STREAM.**

If problems arise with the flow meter and monitor, consult the *“Troubleshooting Guide” on page 12*. If further problems arise, consult the factory.

If the internal components of the turbine flow meter are damaged, order a turbine meter repair kit. See *“Repair Kits” on page 9*.

**Wiring**

Typical wiring configurations for the pickup options are shown in *Figure 4, Figure 5 on page 8, and Figure 6 on page 8.*

Option Number	Description	Number of Pins
0	NEMA 6 – Magnetic	3
1	NEMA 6 – Magnetic (Amplified)	3
2	Non-NEMA 6 – Magnetic	2
3	Non-NEMA 6 – Magnetic (Amplified)	3
4	Non-NEMA 6 – Active (4...20 mA)	5
6	Non-NEMA 6 – Magnetic (High Temperature)	2
8	Non-NEMA 6 – Active (0...5V DC)	5
9	No Pickup	N/A

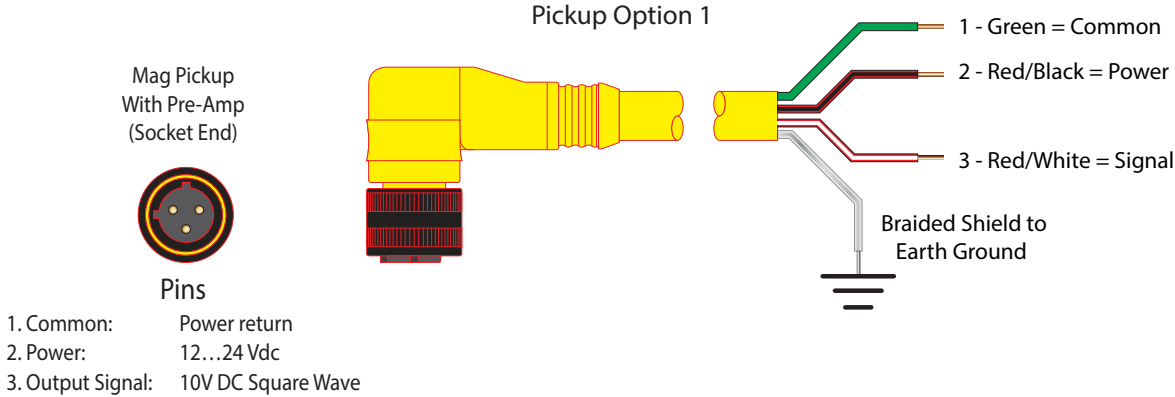
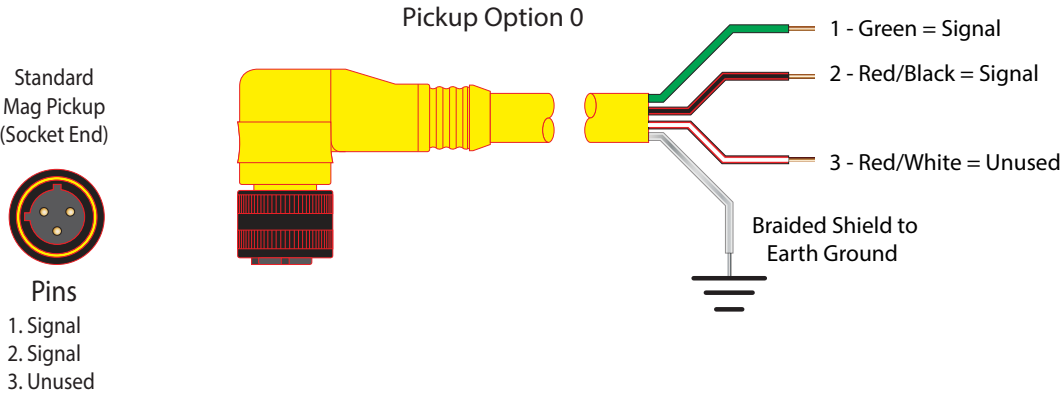

Figure 4: Wiring for NEMA 6 magnetic pickups

Standard  
Mag Pickup  
(Socket End)



**Pins**  
A = Signal  
B = Signal

Pickup Option 2 & 6

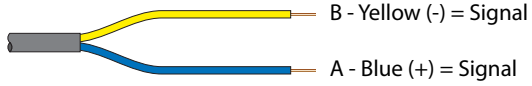
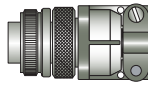

Amplified  
Mag Pickup  
(Socket End)



**Pins**  
A = Power  
B = Common  
C = Output Signal

Pickup Option 3

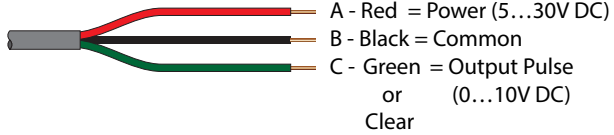
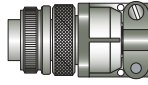
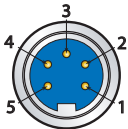

Figure 5: Wiring for non-NEMA 6 magnetic pickups

Active Sensor  
4...20 mA  
(Socket End)



**Pins**  
1 = Loop (+)  
2 = Loop (-)  
3 = N/C  
4 = N/C  
5 = N/C

Pickup Option 4

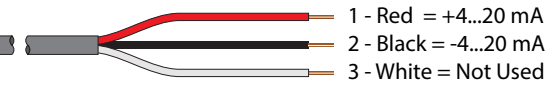
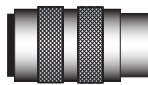

Active Sensor  
0...5V DC  
(Socket End)

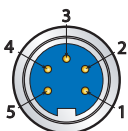

**Pins**  
1 = 10...30V DC  
2 = 0...5V DC Output  
3 = Ground  
4 = N/C  
5 = N/C

Pickup Option 8

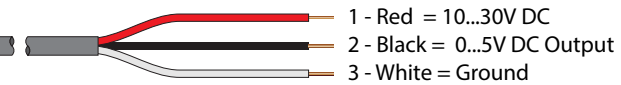
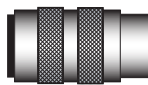

Figure 6: Wiring for active magnetic pickups



## OPERATIONAL STARTUP

Follow this procedure to start the meter:

### WARNING

**MAKE SURE THAT FLUID FLOW HAS BEEN SHUT OFF AND PRESSURE IN THE LINE RELEASED BEFORE ATTEMPTING TO INSTALL THE METER IN AN EXISTING SYSTEM.**

1. After installing the meter, close the isolation valves and open the bypass valve.
2. Flow liquid through the bypass valve for sufficient time to eliminate any air or gas in the flow line.
3. Open the upstream isolating valve slowly to eliminate hydraulic shock while charging the meter with the liquid.
4. Open the valve to full open.

### CAUTION

**HIGH VELOCITY AIR OR GAS MAY DAMAGE THE INTERNAL COMPONENTS OF THE METER.**

5. Open the downstream isolating valve so the meter can operate properly.
6. Close the bypass valve to the fully closed position.
7. Adjust the downstream valve to provide the required flow rate through the meter.

**NOTE:** The downstream valve may be used as a control valve.

## METER REPAIR AND CLEANING

### Repair Kits

Each FloClean repair kit is factory calibrated for accuracy throughout the entire flow range. Each kit is complete and includes a new K-factor, which is the calibrated number of pulses generated by each gallon of liquid. This K-factor is used to recalibrate the monitor or other electronics for accurate output data.

### Turbine Repair Kits Part Numbers

Bore Size	Ferrule Size	Repair Kit Fits Meter Part Number	Part Number Code	Repair Kit Part Number
3/8 in. (9.53 mm)	0.984 in. (24.99 mm)	B16D-003A-XXX	003	B16D-K03A
1/2 in. (12.7 mm)	0.984 in. (24.99 mm)	B16D-005A-XXX	005	B16D-K05A
3/4 in. (19.05 mm)	0.984 in. (24.99 mm)	B16D-007A-XXX	007	B16D-K07A
1/2 in. (12.7 mm)	1.984 in. (50.39 mm)	B16D-105A-XXX	105	B16D-K05A
3/4 in. (19.05 mm)	1.984 in. (50.39 mm)	B16D-107A-XXX	107	B16D-K07A
7/8 in. (22.23 mm)	1.984 in. (50.39 mm)	B16D-108A-XXX	108	B16D-K08A
1 in. (25.4 mm)	1.984 in. (50.39 mm)	B16D-110A-XXX	110	B16D-K10A
1-1/2 in. (38.1 mm)	1.984 in. (50.39 mm)	B16D-115A-XXX	115	B16D-K15A
2 in. (50.8 mm)	3.047 in. (77.39 mm)	B16D-220A-XXX	220	B16D-K20A

## Service Procedures

### **⚠ WARNING**

**HIGH-PRESSURE LEAKS ARE DANGEROUS AND CAUSE PERSONAL INJURY. MAKE SURE THAT FLUID FLOW HAS BEEN SHUT OFF AND PRESSURE IN THE LINE RELEASED BEFORE ATTEMPTING TO REMOVE THE METER.**

### 3-A Turbine Disassembly and Cleaning Procedure

See *Figure 7* for relative positions of the repair kit components.

1. Remove the magnetic pickup from the meter body.
2. Remove the retaining ring from one end of the meter.
3. Keeping the meter upright (pickup port at the top), remove the rotor support from the body, taking care not to rotate it in the process. If the rotor support is jammed in the body, use a pair of pliers or vice grips to break it free.
4. Hold the rotor support over a suitable container and rotate it through 180°. The thrust ball will drop out. Do not lose the ball.
5. Remove the rotor assembly.
6. Remove the second retaining ring from the opposite side of the meter.
7. Repeat steps 3 and 4 for the remaining rotor support.
8. Identify parts and flow direction to match with original meter body.
9. Clean and/or sanitize parts to meet appropriate sanitary standards.

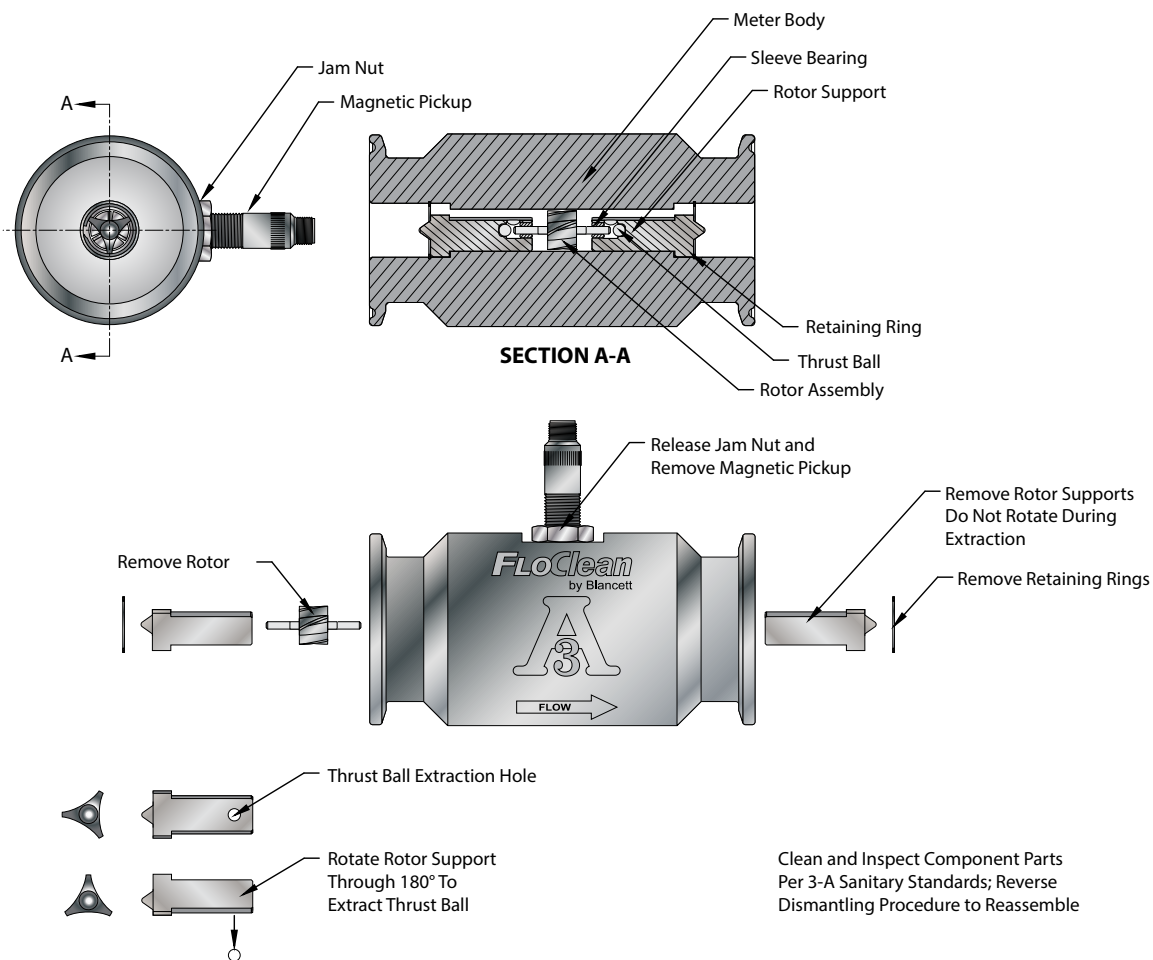

Figure 7: Positions of repair kit components

---

## B16D SERIES (COP/SOP) 3-A TURBINE INSTALLATION

**NOTE:** This procedure applies to installation of replacement turbine repair kits and re-installation of cleaned or sanitized turbine.

### IMPORTANT

*Before reassembly, note the weep holes on each rotor support. These weep holes must be facing down toward the bottom of the meter body when installed.*

The meter must be reassembled with the arrowheads on the rotor pointed in the direction of fluid flow. The magnetic pickup side of the body signifies the up position. This is the position that the repair kit was calibrated. Due to the polished surfaces, there are no arrows on the rotor support to indicate which rotor support is to be placed upstream or downstream. Install the repair kit as it was received in the box, using the arrow on the rotor to determine the placement of the rotor support.

1. If required by process procedures, clean the meter prior to installing it.
2. Drop a thrust ball into a rotor support through the hole in the side.
3. Insert the rotor support into the meter body.
4. Keep the thrust bearing hole pointed upwards to keep the ball in place.
5. Secure a retaining ring in the groove. Be sure that the retaining ring is completely installed in the groove.
6. Drop a thrust ball into second rotor support through the hole in the side.
7. Locate the rotor in the support sleeve bearing.
8. Insert the rotor support and the rotor into the meter body and the first support sleeve bearing.
9. Keep the thrust bearing hole pointed upwards to keep the ball in place.
10. Secure the second retaining ring in the groove. Be sure that the retaining ring is completely installed in the groove.

### CAUTION

**EXCESS AIR PRESSURE MAY DAMAGE THE ROTOR AND BEARINGS BY OVER-SPIN.**

11. Check the meter by blowing air through the assembly. If the rotor does not turn freely, the meter should be disassembled and checked for anything that would obstruct movement of the rotor.
12. Install the magnetic pickup.

**NOTE:** After installing the new repair kit, the electronics will need re-calibration. Refer to the electronics' installation and operation manual. If there are any questions on re-calibration, contact Blancett at 1.800.235.1638 or contact the manufacturer of the electronics.

## TROUBLESHOOTING GUIDE

Issue	Possible Cause	Remedy
Meter indicates higher than actual flow rate	<ul style="list-style-type: none"> <li>• Cavitation</li> <li>• Debris on rotor support</li> <li>• Build up of foreign material on meter bore</li> <li>• Gas in liquid</li> </ul>	<ul style="list-style-type: none"> <li>• Increase back pressure</li> <li>• Clean meter</li> <li>• Clean meter</li> <li>• Install gas eliminator ahead of meter</li> </ul>
Meter indicates lower than actual flow rate	<ul style="list-style-type: none"> <li>• Debris on rotor</li> <li>• Worn bearing</li> <li>• Viscosity higher than calibrated</li> </ul>	<ul style="list-style-type: none"> <li>• Clean meter and add filter</li> <li>• Install new repair kit</li> <li>• Recalibrate monitor</li> </ul>
Erratic system indication, meter alone works well (remote monitor application only)	Ground loop in shielding	Ground shield one place only. Look for internal electronic instrument ground. Reroute cables away from electrical noise.
Indicator shows flow when shut off	Mechanical vibration causes rotor to oscillate without turning	Isolate meter
No flow indication, full or partial open position	Fluid shock, full flow into dry meter or impact caused bearing separation or broken rotor shaft	Rebuild meter with repair kit and recalibrate monitor. Move to location where meter is full on startup or add downstream flow control valve.
Erratic indication at low flow, good indication at high flow	Rotor has foreign material wrapped around it	Clean meter and add filter
No flow indication	Faulty pickup	Replace pickup
System works perfect, except indicates lower flow over entire range	Bypass flow, leak	Repair or replace bypass valves or faulty solenoid valves
Meter indicating high flow, upstream piping at meter smaller than meter bore	Fluid jet impingement on rotor	Change piping
Opposite effects of above	Viscosity lower than calibrated	Change temperature, change fluid or recalibrate meter

## 3-A CERTIFICATE

ISSUE DATE: March 19, 1998

CERTIFICATE AUTHORIZATION NUMBER: 956



THIS IS TO CERTIFY THAT

Badger Meter, Inc.

PO Box 245036, Milwaukee, WI 53224-9536

is hereby authorized to continue to apply the  
3-A Symbol to the models of equipment, conforming to 3-A Sanitary Standards for:

Number 28-06  
28-06 (Flow Meters)

set forth below

COP Models: Turbine Flow Meters - Models #B/BP/BFC/BAW16D-  
003A/005A/007A/105A/107A/108A/110A/115A/220A-xxx

VALID THROUGH: **December 31, 2020**

Timothy R. Rugh  
Executive Director  
3-A Sanitary Standards, Inc.

The issuance of this authorization for the use of the 3-A Symbol is based upon the voluntary certification, by the applicant for it, that the equipment listed above complies fully with the 3-A Sanitary Standard(s) designated. Legal responsibility for compliance is solely that of the holder of this Certificate of Authorization, and 3-A Sanitary Standards, Inc. does not warrant that the holder of an authorization at all times complies with the provisions of the said 3-A Sanitary Standards. This in no way affects the responsibility of 3-A Sanitary Standards, Inc. to take appropriate action in such cases in which evidence of nonconformance has been established.

NEXT TPV INSPECTION/REPORT DUE: **May 2021**

## SPECIFICATIONS

<b>Materials of Construction</b>	<b>Body</b>	316L stainless steel
	<b>Rotor</b>	Nickel plated CD4MCU stainless steel
	<b>Bearings</b>	Standard-nickle bindery tungsten carbide
	<b>Rotor Shaft</b>	Nickel bindery tungsten carbide
	<b>Rotor Support</b>	—
<b>Operating Temperature</b>	-150...300° F (-100...149° C)	
<b>Pressure Rating</b>	1,000 psi (Rating based on tri-clamp sanitary connection)	
<b>End Connections</b>	Sanitary clamp end	
<b>Turndown Ratio</b>	—	
<b>Accuracy</b>	±1.0% of reading	
<b>Repeatability</b>	±0.1%	
<b>Calibration</b>	Water (NIST traceable calibration)	
<b>Mag Pickup</b>	NEMA 6; -150...300° F (-100...149° C)	
<b>Certifications</b>		

## PART NUMBER INFORMATION

Part Number Code	Bore Size	End Connections	Max PSI	Flow Rate			Strainer Mesh	Approx. K-Factor Pulse/US Gal	Meter Weight (lb)	Ferrule Size in. (mm)	End to End Length in. (mm)
				gpm (lpm)	bpd	m <sup>3</sup> /d					
<b>003</b>	3/8 in. (9.53 mm)	0.984 in. (25.0 mm)	1000	0.60...3.00 (2.27...11.36)	20.57...102.86	3.27...16.35	—	20,000	—	0.984 (24.99)	3.00 (76.2)
<b>005</b>	1/2 in. (12.7 mm)	0.984 in. (25.0 mm)	1000	0.75...7.50 (2.84...28.39)	21.71...257.14	4.09...40.88	—	13,000	—	0.984 (24.99)	3.00 (76.2)
<b>007</b>	3/4 in. (19.05 mm)	0.984 in. (25.0 mm)	1000	2.00...15.00 (7.57...56.78)	68.57...514.29	10.90...81.76	—	2750	—	0.984 (24.99)	3.00 (76.2)
<b>105</b>	1/2 in. (12.7 mm)	1.984 in. (50.4 mm)	1000	0.75...7.50 (2.84...28.39)	21.71...257.14	4.09...40.88	—	13,000	—	1.984 (50.39)	4.00 (101.60)
<b>107</b>	3/4 in. (19.05 mm)	1.984 in. (50.4 mm)	1000	2.00...15.00 (7.57...56.78)	68.57...514.29	10.90...81.76	—	2750	—	1.984 (50.39)	4.00 (101.60)
<b>108</b>	7/8 in. (22.23 mm)	1.984 in. (50.4 mm)	1000	3.00...30.00 (11.36...113.56)	102.86...1028.57	16.35...163.53	—	2686	—	1.984 (50.39)	4.00 (101.60)
<b>110</b>	1 in. (25.4 mm)	1.984 in. (50.4 mm)	1000	5.00...50.00 (18.93...189.27)	171.43...1714.29	27.25...272.55	—	870	—	1.984 (50.39)	4.00 (101.60)
<b>115</b>	1-1/2 in. (38.1 mm)	1.984 in. (50.4 mm)	1000	15.00...180.00 (56.78...681.37)	514.29...6171.43	81.76...981.18	—	330	—	1.984 (50.39)	6.25 (158.8)
<b>220</b>	2 in. (50.8 mm)	3.047 in. (77.4 mm)	1000	40.00...400.00 (151.42...1514.16)	1371.43...13714.29	218.04...2180.40	—	52	—	3.047 (77.39)	6.50 (165.1)

## DIMENSIONS AND DRAWING

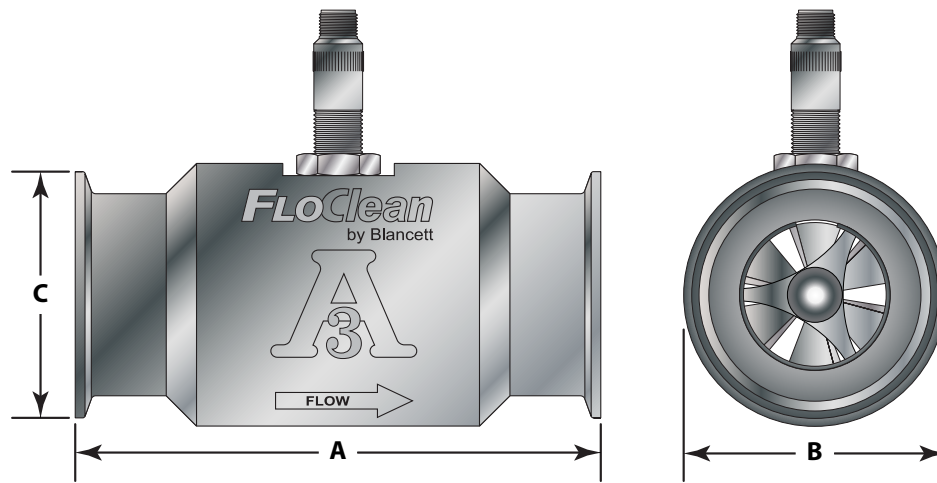

Part No.	Part Number Code	A End to End	B Diameter	C Ferrule Size
<b>B16D-0XXA-XXX</b>	003 005 007	3.00 in. (76.2 mm)	1.46 in. (37.1 mm)	0.984 in. (25.0 mm)
<b>B16D-1XXA-XXX</b>	105 107 108 110	4.00 in. (101.6 mm)	2.00 in. (50.8 mm)	1.984 in. (50.4 mm)
<b>B16D-1XXA-XXX</b> <sup>1</sup>	115 <sup>1</sup>	6.25 in. (158.8 mm)	2.33 in. (59.2 mm)	1.984 in. (50.4 mm)
<b>B16D-2XXA-XXX</b>	220	6.50 in. (165.1 mm)	3.20 in. (81.3 mm)	3.047 in. (77.4 mm)

<sup>1</sup> 15.0...180.0 gpm flow range only.

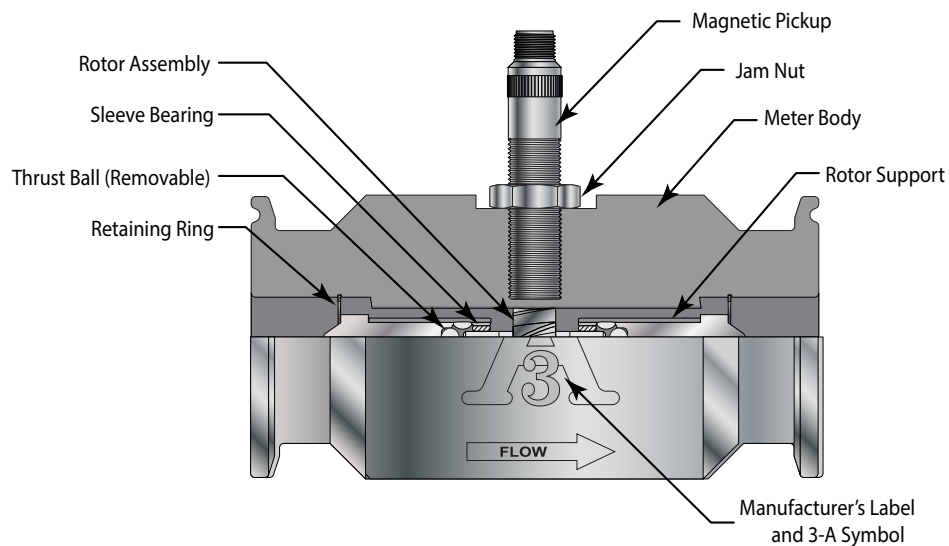

## PART NUMBERING CONSTRUCTION

### Blancett Turbine Flow Meters FloClean: COP/SOP 3-A Compliant



#### FERRULE & METER SIZE

Ferrule: 0.984 in.   3/4 in. Clamp x 3/8 in. Bore	003
Ferrule: 0.984 in.   3/4 in. Clamp x 1/2 in. Bore	005
Ferrule: 0.984 in.   3/4 in. Clamp x 3/4 in. Bore	007
Ferrule: 1.984 in.   1-1/2 in. Clamp x 1/2 in. Bore	105
Ferrule: 1.984 in.   1-1/2 in. Clamp x 3/4 in. Bore	107
Ferrule: 1.984 in.   1-1/2 in. Clamp x 7/8 in. Bore	108
Ferrule: 1.984 in.   1-1/2 in. Clamp x 1 in. Bore	110
Ferrule: 1.984 in.   1-1/2 in. Clamp x 1-1/2 in. Bore	115
Ferrule: 3.047 in.   2-1/2 in. Clamp x 2 in. Bore	220

#### BEARING

Nickel Bindery; Tungsten Carbide	A
----------------------------------	---

#### PICKUP

Magnetic   <i>NEMA 6</i>	0
Magnetic with Pre-Amplifier   <i>NEMA 6</i>	1
<sup>1</sup> Magnetic   <i>Standard</i>	2
<sup>1</sup> Magnetic with Pre-Amplifier   <i>Standard</i>	3
<sup>1</sup> Magnetic with F/I Converter (Active 4...20 mA Output)	4
<sup>1</sup> Magnetic   <i>High Temperature (-450...450° F/-268...232° C)</i>	6
Magnetic with Pre-Amplifier   <i>NEMA 6 (Less Zenor)</i>	7
<sup>1</sup> Magnetic with F/V Converter (Active 0...5V DC Output)	8
No Pickup	9

#### METER BODY HUB

With Hub   1/2 in. Hub for Ferrule Size 0.984; 1 in. Hub for 1.984 in. and 3.047 in	A
No Hub	B

#### CALIBRATION

5-Point   <i>Standard</i>	A
10-Point	B
20-Point	C

<sup>1</sup> For Indoor Use Only

Example Part Number: B16D-110A-2AA

### Control. Manage. Optimize.

Blancett is a registered trademark of Badger Meter, Inc. Other trademarks appearing in this document are the property of their respective entities. Due to continuous research, product improvements and enhancements, Badger Meter reserves the right to change product or system specifications without notice, except to the extent an outstanding contractual obligation exists. © 2019 Badger Meter, Inc. All rights reserved.

[www.badgermeter.com](http://www.badgermeter.com)