

PR-50 Series

Diaphragm-type High Pressure Regulator



The PR-50 Series pressure regulator is designed to meet the demands for outlet pressures up to 2000 psig while maintaining superior corrosion protection.

For reliability in operation, this precision regulator features a stainless steel body (optional brass) which provides maximum corrosion resistance and safety. The optional self-relieving feature provides an additional level in operational ease, as it allows for trapped downstream pressure to be safely vented to atmosphere through the bonnet.

To prolong regulator life, this unit is supplied with an integral inlet filter which protects the seat against any foreign contamination introduced by the upstream supply.

Features & Specifications

- Gas or liquid service
- Inlet pressure to 6000 psig
- Outlet pressure ranges 0–500, 0–1000, and 0–2000 psig
- 316L stainless steel or Brass (alloy 360) construction
- 20 micron inlet filter
- Bubble-tight shutoff
- 1/4" FNPT standard
- Diaphragm material standard stainless steel, nylon or PTFE
- Flow coefficients (Cv) of 0.025, 0.06, and 0.20

Applications

- R & D systems
- Cylinder gas regulation
- Sampling systems
- Airline charging carts
- Pilot plants
- Offshore drillings

pressure regulators

PR-50 Series

To Order, contact your local Distributor Link below:
www.goreg.com/distributor/index.htm

Verify that your chosen part number is valid using the GO Wizards at
www.goreg.com/products/matrix/index.htm

How to Order

PR50 –

BODY MATERIAL

- 1 316L stainless steel
- 2 Brass
- 4 MONEL®
- 8 Chrome plated brass

PORT CONFIGURATION

- A Standard
- For more port configurations, see page 33.

PROCESS PORT TYPES

(GAUGE PORT TYPES, IF SPECIFIED)

- 1 ¼" FNPT (¼" FNPT gauge ports)
- 4 ⅜" FNPT (¼" FNPT gauge ports)

SURFACE FINISH OF DIAPHRAGM CAVITY

- 1 < 25 Ra, standard

SEAT MATERIAL

- A Tefzel®
- H PCTFE (formerly Kel-F® 81)
- Q PEEK™

FLOW COEFFICIENT (Cv)

- 3 0.06
- 5 0.2
- C 0.025

OPTIONS

- A EB33
- B EB5
- D Helium leak test
- E Pressure test certificate
- F Certificate of Conformity
- G CMTR

CAP ASSEMBLY

- 1 Standard, aluminum
- 4 Panel mount, aluminum
- 5 Captured vent, aluminum
- 6 Captured vent, panel mount, aluminum
- 7 Captured vent, stainless steel
- 9 Plastic knob, stainless steel
- A Captured vent, plastic knob, stainless steel
- B Panel mount, plastic knob, stainless steel
- F Stainless steel panel mount
- V Captured vent, stainless steel
- W Panel mount, stainless steel

DIAPHRAGM FACING/BACKING MATERIAL

	Facing	Backing	O-rings	Actuator
1	St. steel	Nylon	Viton®	St. steel
2	—	Nylon	PTFE	St. steel
3	Polyimide	Nylon	Viton®	St. steel
4	St. steel	Nylon	PTFE	St. steel
5	—	Nylon	PTFE	MONEL®
6	Polyimide	Nylon	PTFE	St. steel
7	INCONEL®	Nylon	Viton®	MONEL®
8	INCONEL®	Nylon	PTFE	MONEL®
B	—	Nylon	Viton®	MONEL®
H	—	Nylon	Viton®	St. steel
Q	St. steel	PTFE	PTFE	St. steel
V	INCONEL®	PTFE	PTFE	MONEL®

DIAPHRAGM TYPE

- 1 Non-self-relieving
- 3 Self-relieving

OUTLET RANGE

- J 0–500 psig
- K 0–1,000 psig
- L 0–2,000 psig

NOTE: Contact the factory for any additional requirements.

Maximum Temperature & Operating Inlet Pressures

Nylon Diaphragm Backing

SEAT MATERIAL	MAXIMUM TEMPERATURE*	@	MAXIMUM OPERATING INLET PRESSURE
Tefzel®	150° F (66° C)	@	3600 psig (24.82 MPa)
PCTFE (formerly Kel-F® 81)	175° F (80° C)	@	6000 psig (41.37 MPa)
PEEK™	175° F (80° C)	@	6000 psig (41.37 MPa)

PTFE Diaphragm Backing

SEAT MATERIAL	MAXIMUM TEMPERATURE*	@	MAXIMUM OPERATING INLET PRESSURE
Tefzel®	150° F (66° C)	@	3600 psig (24.82 MPa)
PCTFE (formerly Kel-F® 81)	175° F (80° C)	@	6000 psig (41.37 MPa)
PEEK™	350° F (176° C)	@	6000 psig (41.37 MPa)

Outline and Mounting Dimensions

Weight = 4.4 lbs (2.0kg)

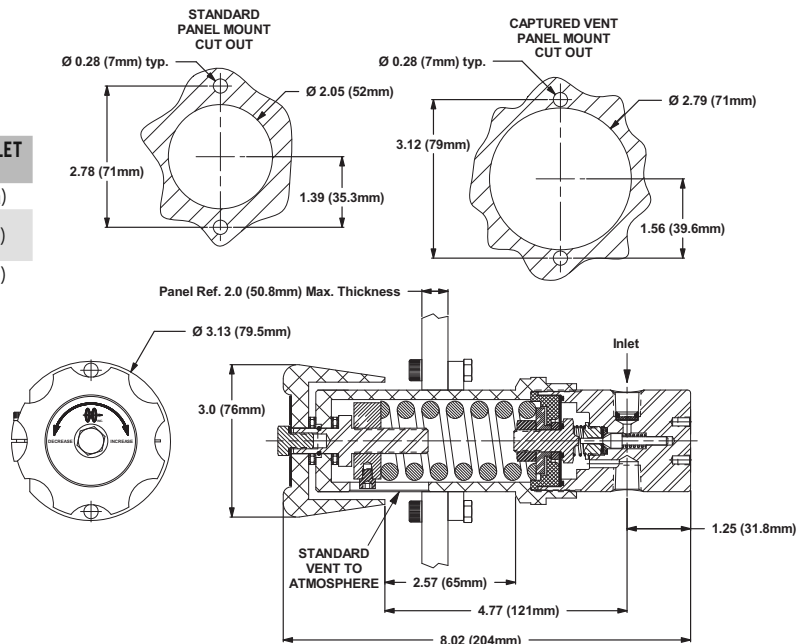

Tefzel® is a registered trademark of the DuPont Company.
 MONEL® is a registered trademark of Special Metals Corporation.
 Kel-F® is a registered trademark of 3M Company.
 PEEK™ is a trademark of Victrex PLC.
 Viton® is a registered trademark of DuPont Dow Elastomers.

Port Locations (Back Pressure Regulators)

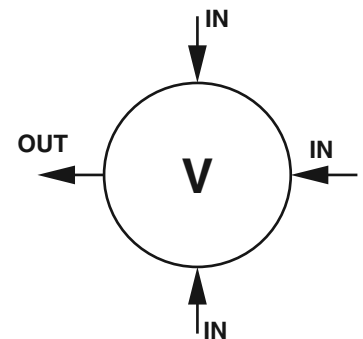
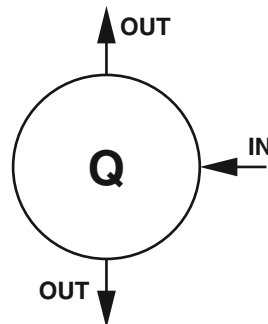
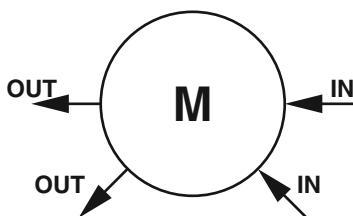
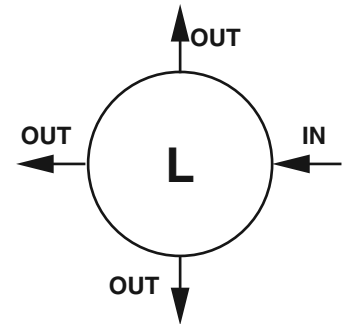
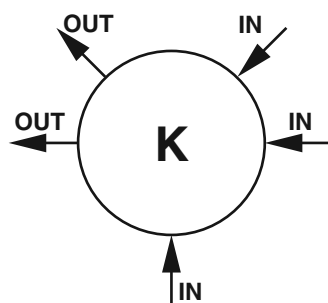
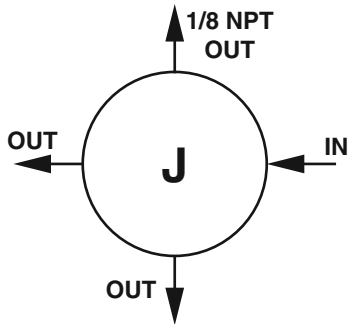
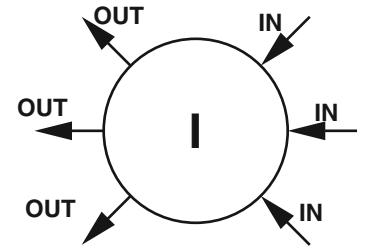
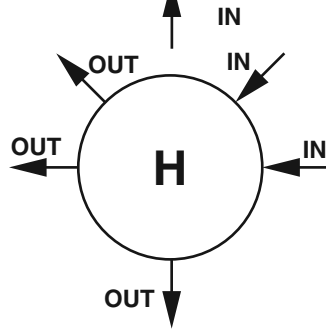
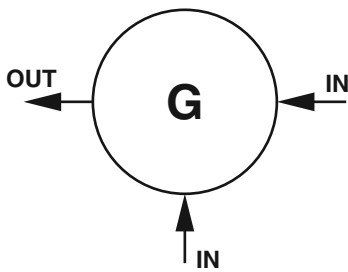
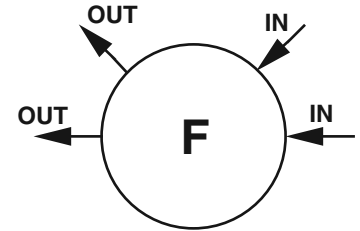
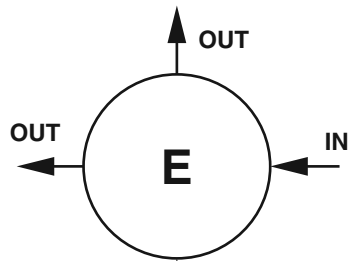
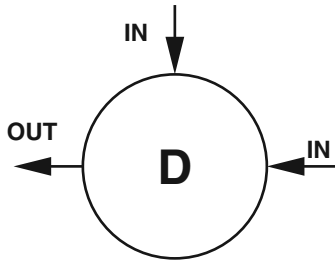
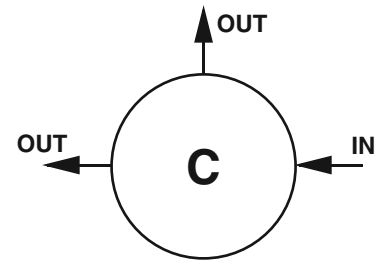
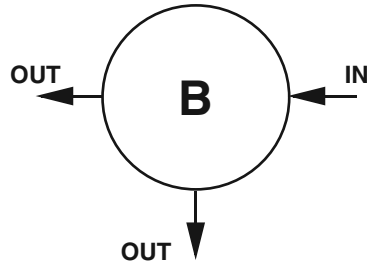
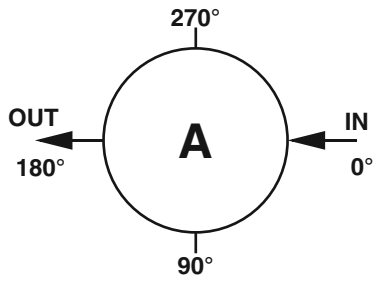

LOCATION OF PORTS FROM TOP VIEW