

PR-7ULF Series

Pressure Reducing Regulator



The PR-7ULF Series pressure reducing regulator is designed to furnish ultra precise low outlet pressure control to analytical instrumentation. With the combination of the large diaphragm sensing area of the PR-7 Series regulator and a super low flow valve seat assembly, pressure control down to 1 inch of water at 2cc of flow is easily obtainable.

Features & Specifications

- Gas service
- 316L stainless steel or Brass (alloy 360) construction
- PTFE / Viton® diaphragm
- Electropolished body (316L) with better than 25 Ra finish in diaphragm cavity
- 20 micron inlet filter
- Bubble-tight shutoff
- Outlet pressure ranges are 0–6, 0–25, 0–50, and 0–100 psig
- Viton® seat
- 0.004 Cv flow coefficient

pressure regulators

PR-7ULF Series

To Order, contact your local Distributor Link below:
www.goreg.com/distributor/index.htm

Verify that your chosen part number is valid using the GO Wizards at
www.goreg.com/products/matrix/index.htm

How to Order

PR7U -

BODY MATERIAL

- 1 316L stainless steel
- 2 Brass

PORT CONFIGURATION

- A Standard
- For more port configurations, see page 33.

PROCESS PORT TYPES

(GAUGE PORT TYPES, IF SPECIFIED)

- 1 1/4" FNPT (1/4" FNPT gauge ports)

SURFACE FINISH OF DIAPHRAGM CAVITY

- 1 < 25 Ra

VENT VALVE

- 0 No
- 1 Yes

DIAPHRAGM TYPE

- 1 Standard

OPTIONS

- A EB33
- B EB5
- D Helium leak test
- E Pressure test certificate
- F Certificate of Conformity
- G CMTR

OUTPUT RANGE

- B 0-6 psig
- D 0-25 psig
- E 0-50 psig
- G 0-100 psig

CAP ASSEMBLY

- 4 Hand knob, 1 3/8" panel mount, stainless steel
- 7 Captured vent, stainless steel
- 8 Tamper-proof, stainless steel
- 9 Fine adjust, 1/2" panel mount, stainless steel
- 0 Fine adjust, 1 3/8" panel mount, stainless steel
- Y Hand knob, stainless steel
- C Captured vent, panel mount, stainless steel

DIAPHRAGM MATERIAL

- 1 Viton®
- 6 Tefzel® ring/stainless steel

NOTE: Contact the factory for any additional requirements.

Maximum Temperature & Operating Inlet Pressures

SEAT MATERIAL	MAXIMUM TEMPERATURE	@	MAXIMUM OPERATING INLET PRESSURE
Viton®	120° F (49° C)	@	250 psig (1.73 MPa)

Outline and Mounting Dimensions

Weight = 3.2 lbs (1.45kg)

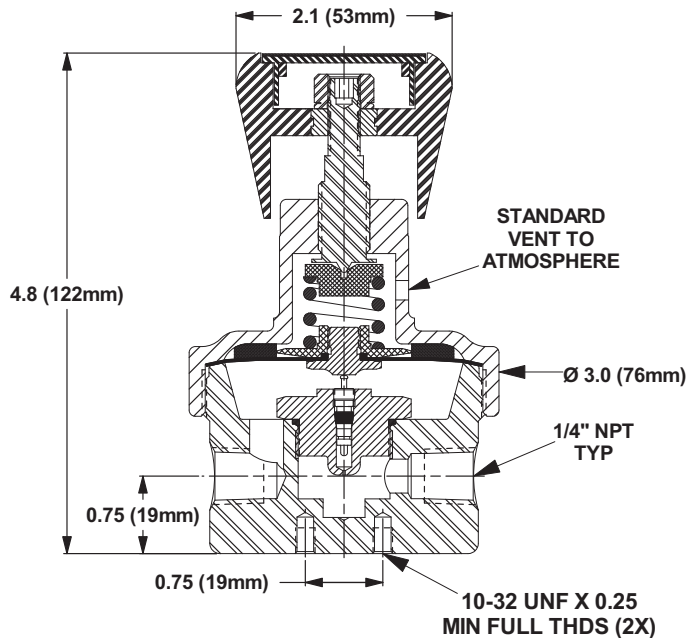

Tefzel® is a registered trademark of the DuPont Company.
 Viton® is a registered trademark of DuPont Dow Elastomers.

Port Locations (Back Pressure Regulators)

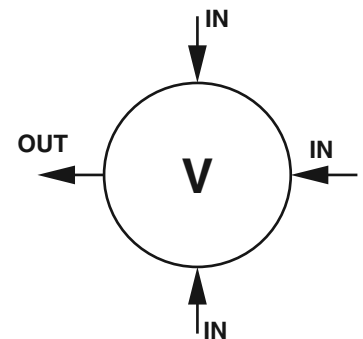
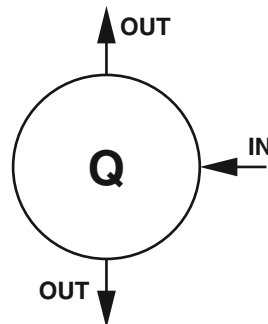
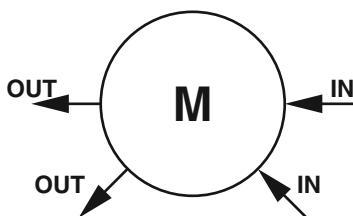
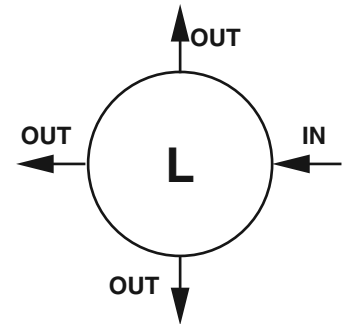
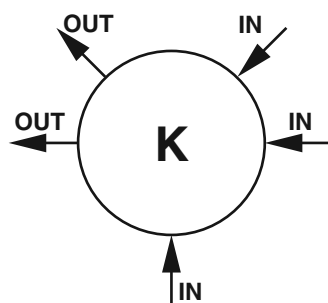
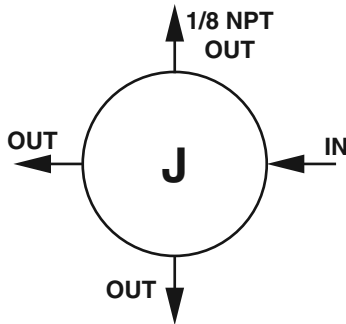
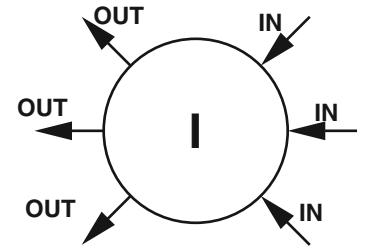
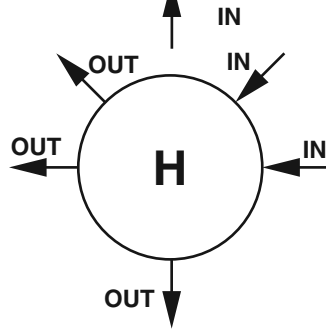
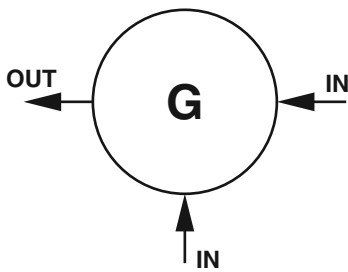
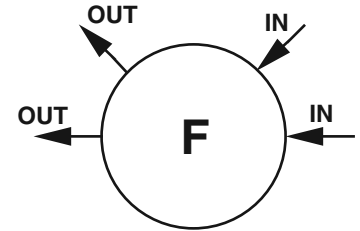
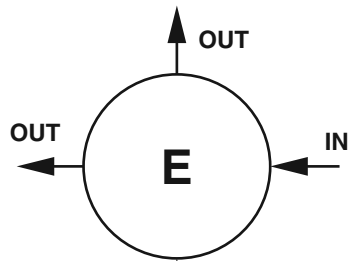
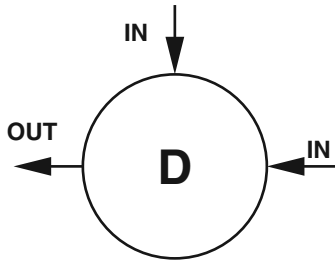
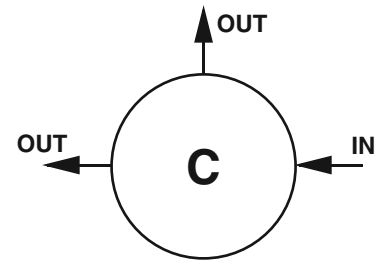
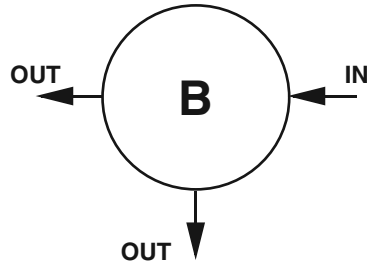
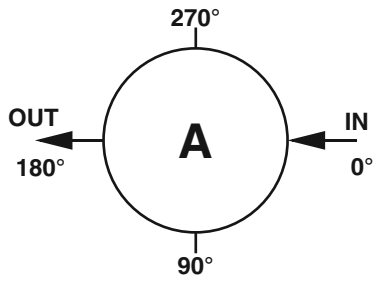

LOCATION OF PORTS FROM TOP VIEW